

RISOGRAPH

**RIA** 4900

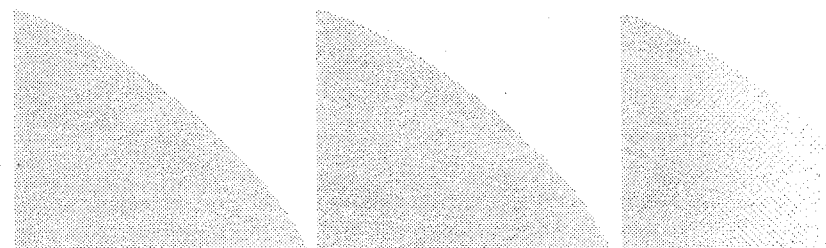

**USER GUIDE**

**RISO**



RISO MAKES NO WARRANTY OF ANY KIND WITH REGARD TO THIS USER GUIDE, INCLUDING, BUT NOT LIMITED TO, THE IMPLIED WARRANTIES OF MERCHANTABILITY AND FITNESS FOR A PARTICULAR PURPOSE. RISO SHALL NOT BE LIABLE FOR ERRORS CONTAINED HEREIN OR FOR INCIDENTAL OR CONSEQUENTIAL DAMAGES IN CONNECTION WITH THE FURNISHING, PERFORMANCE, OR USE OF THIS USER GUIDE. RISO ASSUMES NO LIABILITY FOR DAMAGES RESULTING FROM THE USE OF THE INFORMATION CONTAINED HEREIN.

### **FCC Warning**

This equipment has been tested and found to comply with the limits for a Class A digital device, pursuant to Part 15 of the FCC Rules. These limits are designed to provide reasonable protection against harmful interference when the equipment is operated in a commercial environment. This equipment generates, uses, and can radiate radio frequency energy and, if not installed and used in accordance with the instruction manual, may cause harmful interference to radio communications. Operation of this equipment in a residential area is likely to cause harmful interference, in which case the user will be required to correct the interference at his own expense.

### **DOC Warning**

This digital apparatus does not exceed the Class A limit for radio noise emissions from digital apparatus as set out in the Radio Interference Regulation of the Canadian Department of Communications.

*Le présent appareil numérique n'émet pas de bruits radioélectriques dépassant les limites applicables aux appareils numériques de Classe A prescrites dans le Règlement sur le Brouillage Radioélectrique édicté par le Ministère des Communications du Canada.*

**Copyright © 1993 RISO KAGAKU CORPORATION**



## Contents

---

<b>Welcome to the RISOgraph RA4900</b> .....	<b>1</b>	<b>Setting Up the Paper Feed Tray</b> .....	<b>14</b>
About This User Guide .....	1	Replacing or Adding Paper .....	14
<b>Installing Your RISOgraph</b> .....	<b>2</b>	Closing the Paper Feed Tray .....	14
Location and Environment .....	2	<b>Setting Up the Paper Receiving Tray</b> .....	<b>15</b>
Power Connections .....	2	Closing the Paper Receiving Tray .....	15
<b>About Your RISOgraph</b> .....	<b>3</b>	<b>Color Printing</b> .....	<b>16</b>
Features .....	3	Changing Color Drum Units .....	16
Knowing the Parts and Components .....	4	<b>Making Masters and Printing</b> .....	<b>18</b>
Upper Block .....	4	Standard Text/Photo Processing .....	20
Paper Feed Block .....	4	Line .....	20
Master-Making Block .....	5	Photo .....	20
Paper Receiving Block .....	5	Enhancing Print Processing .....	20
Front Block .....	5	Fine Enhance .....	20
Using the Control Panel .....	6	Dot Photo .....	20
Main Panel .....	6	Adjusting Scanning Contrast .....	21
Sub Panel .....	8	Checking Print Quality .....	21
Panel Displays .....	9	Reducing or Enlarging Originals .....	22
<b>About Printing Paper</b> .....	<b>10</b>	Using Preset Ratios .....	22
Selecting Printing Paper .....	10	Using Zoom Ratios .....	23
Storing Paper .....	10	Positioning the Print .....	24
<b>About Your Originals</b> .....	<b>11</b>	Adjusting Vertical Print Position .....	24
<b>Quick Overview</b> .....	<b>12</b>	Adjusting Horizontal Print Position .....	24
Setting Up .....	12	Adjusting Print Speed or Printing Density .....	25
Making Masters .....	12	Adjusting Print Speed .....	25
Printing .....	13	Adjusting Printing Density .....	25
		Protecting Confidential Documents .....	26
		One-Step Printing .....	27
		Printing Two Originals Side by Side .....	28
		Printing Two Different Originals Two-Up .....	28
		Printing the Same Original Twice or	
		Changing Settings for One Original .....	29



Automatic Sorting into Groups .....	31
Setting Up Program A .....	32
Setting Up Program B .....	33
Programming the Same Quantity for Several Groups .....	35
Storing Settings in Memory .....	36
Saving Settings .....	36
Recalling Saved Settings .....	37
Deleting Saved Settings .....	38
<b>Automatic Maintenance .....</b>	<b>39</b>
<b>Return to Initial Settings .....</b>	<b>39</b>
<b>Customizing the Initial Settings .....</b>	<b>40</b>
<b>Maintaining Your RISOgraph .....</b>	<b>41</b>
Replacing the Lithium Battery .....	41
Cleaning Your RISOgraph .....	42
Cleaning the Thermal Print Head .....	42
Cleaning the Scanner .....	42
Cleaning the Press Roller .....	42
Cleaning the Machine Exterior .....	42
Replacing the Ink Bottle .....	43
Replacing the Master Roll .....	44
Emptying the Master Disposal Box .....	46

<b>Advisory Messages .....</b>	<b>47</b>
CHECK SETTINGS Display .....	48
ADD PAPER Display .....	49
REPLACE INK BOTTLE Display .....	49
REPLACE MASTER ROLL Display .....	49
EMPTY DISPOSAL BOX Display .....	49
PAPER JAM Display .....	50
MASTER MISFEED Display .....	51
SORTER ERROR Display .....	52
CALL SERVICE Display .....	52
<b>Troubleshooting .....</b>	<b>53</b>
<b>Optional Accessories .....</b>	<b>54</b>
<b>Specifications .....</b>	<b>55</b>
<b>Settings Saved in Memory .....</b>	<b>56</b>









# Welcome to the RISOgraph RA4900

## About This User Guide

This *Guide* provides all of the information necessary to use your new RISOgraph RA4900. It is designed to help you take advantage of the features built into the RISOgraph RA4900. It also provides information about how to maintain your RISOgraph and solve problems.

- Control panel buttons and displays are clearly indicated, like this:

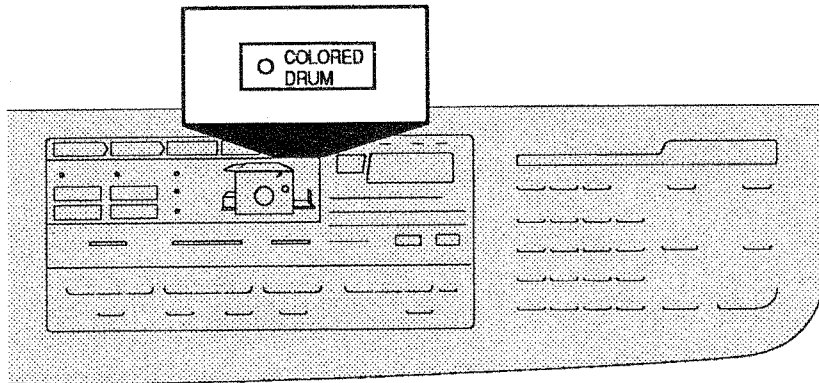

- Indicators that are lit, to show you when a feature or mode is active, are presented with the associated button or icon, like this:



- Procedures for using the RISOgraph are presented with simple numbered steps, like this:

### 1 Set the original into place.

- Special information is presented like this:

**Note** Change Drum Units with the power ON.

### **Important!**

**Do not mix printing paper of different sizes.**

- Safety information is presented, like this:

 **Caution**

 **WARNING**

- When you can find more details in another section of the *User Guide*, cross-references are provided, like this:

➔ **Page 53-54** — See "Troubleshooting" for further information.



## Installing Your RISOgraph

---

### Location and Environment

#### Caution

- Install the machine near the electrical outlet to avoid using an extension cord between the machine and the electrical outlet.
- Do not allow anything to rest on or roll over the power cord, and do not place the machine where the power cord is subject to traffic or abuse. This can result in a shock or fire hazard.
- Maintain adequate distance from rear wall to allow easy connection/disconnection of the power cord.

#### **Note** To avoid mechanical problems:

- Avoid dusty locations.
- Select a location where the machine will be level.
- Avoid locations where direct sunlight will fall on the machine. If it is unavoidable, protect the machine with a curtain or shade on windows.
- Install within the recommended temperature range: 50° F to 86° F (10° C to 30° C) with moderate humidity.
- Avoid locations where heat or air is directed onto the machine from an air conditioner or a heater.

### Power Connections

#### **WARNING – To Avoid Personal Injury**

- Securely insert the power cord plug into the electrical outlet.
- Do not overload the electrical outlet or extension cord, as this can result in fire or electrical shock.



## About Your RISOgraph

The RISOgraph RA4900 is a high-quality scanner/printer that is as easy to use as a copier.

### Features

#### Print Speed and Printing Density Control

Any of five print speeds and printing densities can be selected for optimum performance.

#### Confidential Feature

A confidential original can be printed and the master can be automatically discarded to prevent further, unauthorized printing.

#### Automatic Idle

This optional feature prevents ink from drying on the Drum Unit when the RISOgraph is not in use for a period of time. This prevents faint or blurred images on the first few sheets when printing starts again.

#### Image and Text Processing Options

In addition to the standard RISOgraph process for sharp line definition and accurate shading patterns, special fine-line enhancement and dot-screen processes are also available.

#### Color Printing Options

Any of six optional ink colors can be used by changing the Drum Unit.

#### Zoom Up and Reduction Capabilities

Prints can be enlarged or reduced from 50% to 200%, according to your needs. Standard ratios are also available.

#### Programmable Print Groupings

Simple control panel entries can automate different types of print groupings to save time finishing your print jobs.

#### Programmable Print Jobs

Frequently used or complex print job settings can be stored in memory for instant recall.

### Two-Up Printing

Originals can be printed side by side on a single sheet.

### Easy to Use

The control panel is designed to show you the options available and the current status of the machine: Indicator lights, easy-to-read digital displays, and a convenient "Machine Monitor" display for troubleshooting.

### Fully Automatic Processing

The RISOgraph RA4900 processes your original by first master-making and then printing. These processes are fully automatic, unless you choose to manually set the processing mode. The Master-Making/Printing indicator always shows the current process.

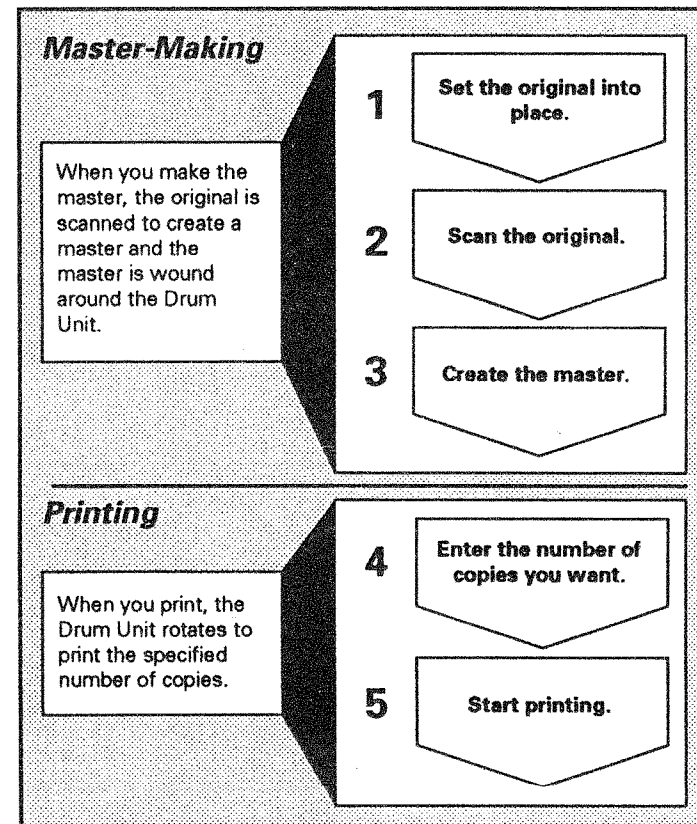





## Knowing the Parts and Components

### Upper Block

- ① **Original Tray**  
Holds scanned originals.
- ② **ADF (Automatic Document Feeder) Unit**  
Feeds originals into the scanner.
- ③ **Original Guides**  
Holds and guides originals for feeding.
- ④ **Original Feed Table**
- ⑤ **Original Feed Table Release Lever**  
Unlocks and opens the Original Feed Table.
- ⑥ **ADF Unit Release Lever**  
Releases an original for removal when it is jammed in the ADF Unit.
- ⑦ **Control Panel**

### Paper Feed Block

- ⑧ **Paper Feed Tray**
- ⑨ **Feed Tray Paper Guides**  
Holds and guides paper.
- ⑩ **Paper Feed Pressure Adjustment Lever**  
Adjusts the paper feed pressure according to the paper being used.
- ⑪ **Left/Right Print Position Adjustment Dial**  
Moves the print position to the left or right.
- ⑫ **Feed Tray Down Button**  
Lowers the Paper Feed Tray for replacing or adding printing paper.
- ⑬ **Master Disposal Box**  
Holds discarded masters.

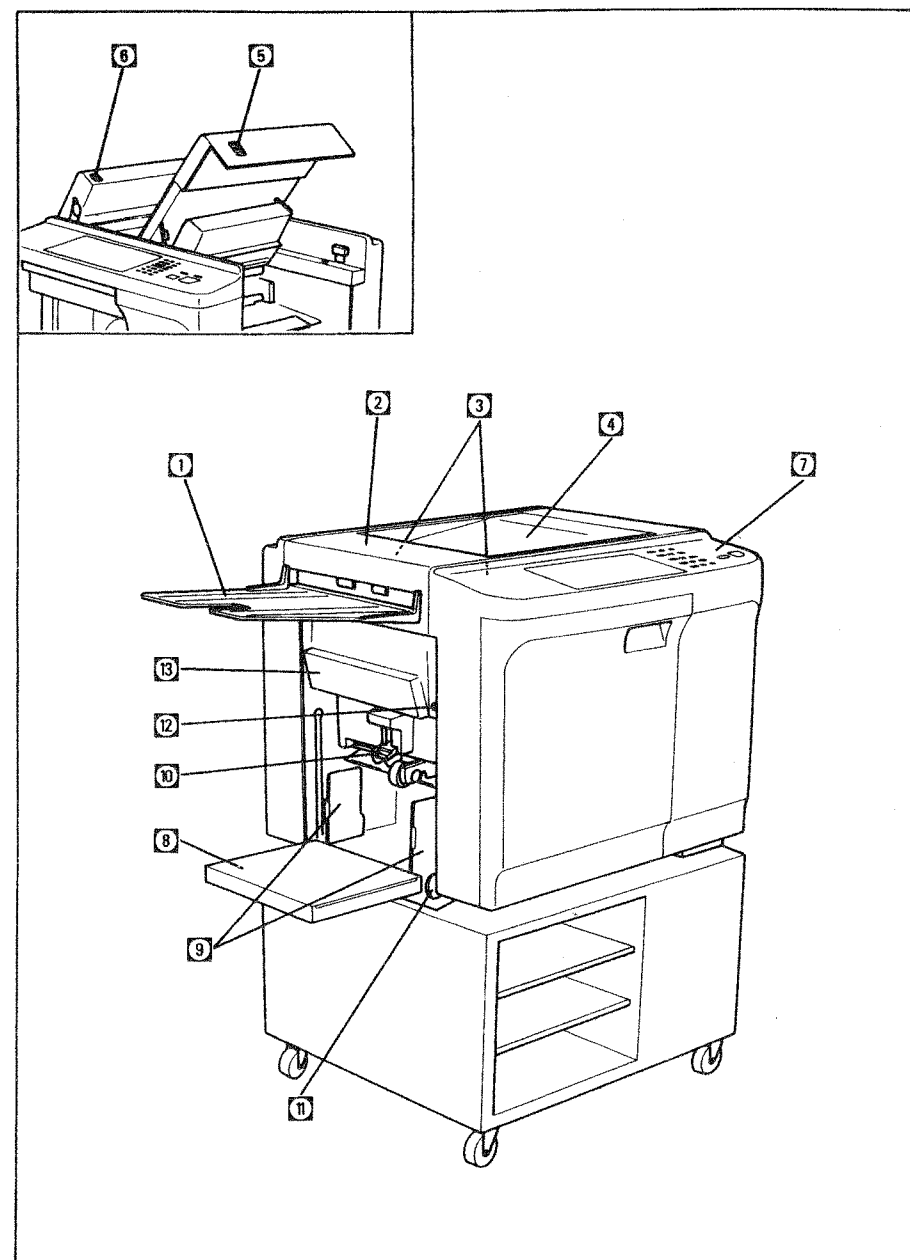



## Master-Making Block

- 14 Master Loading Unit Release Lever**  
Opens the Master Loading Unit.
- 15 Master Loading Unit**  
Makes a master from the scanned original.
- 16 Master Loading Button**  
Loads and/or cuts the master.

- 17 Master Roll Cover**  
Protects the Master Roll.
- 18 Master Roll**

## Paper Receiving Block

- 19 Paper Receiving Tray**
- 20 Receiving Tray Paper Guides**  
Aligns printed paper neatly.
- 21 Paper Guiding Arms**  
Guides printed paper into the Paper Receiving Tray.
- 22 Paper Stop**  
Stops printed paper ejected into the Paper Receiving Tray.

## Front Block

- 23 Front Cover**
- 24 Drum Unit**  
Holds the master on its surface.
- 25 Ink Bottle**
- 26 Ink Bottle Locking Lever**  
Secures the ink bottle in position.
- 27 Drum Handle**  
Used to pull the Drum Unit out of the machine.
- 28 Drum Home Position Button**  
Positions and unlocks the Drum Unit for removal.
- 29 Power Switch**

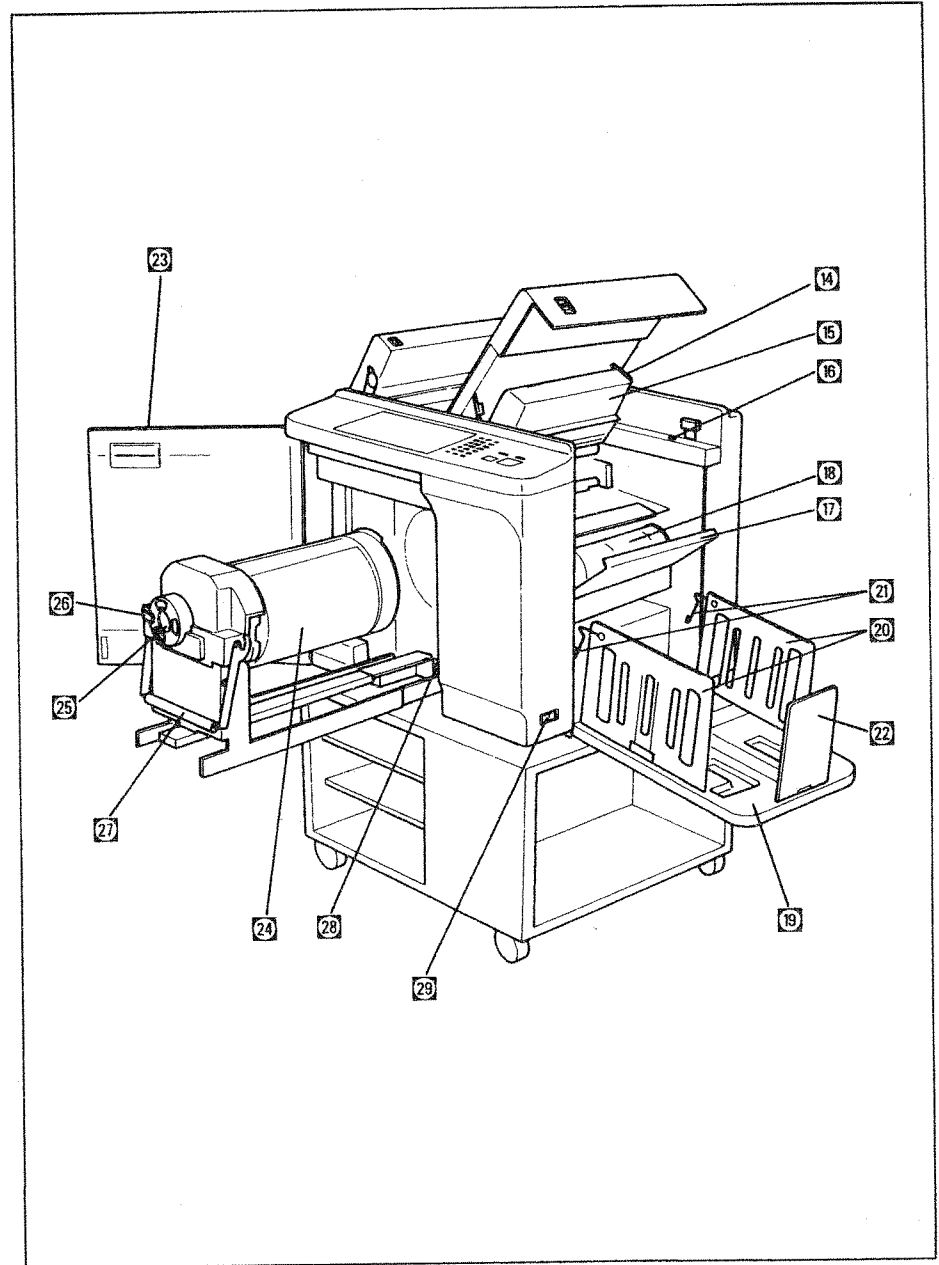



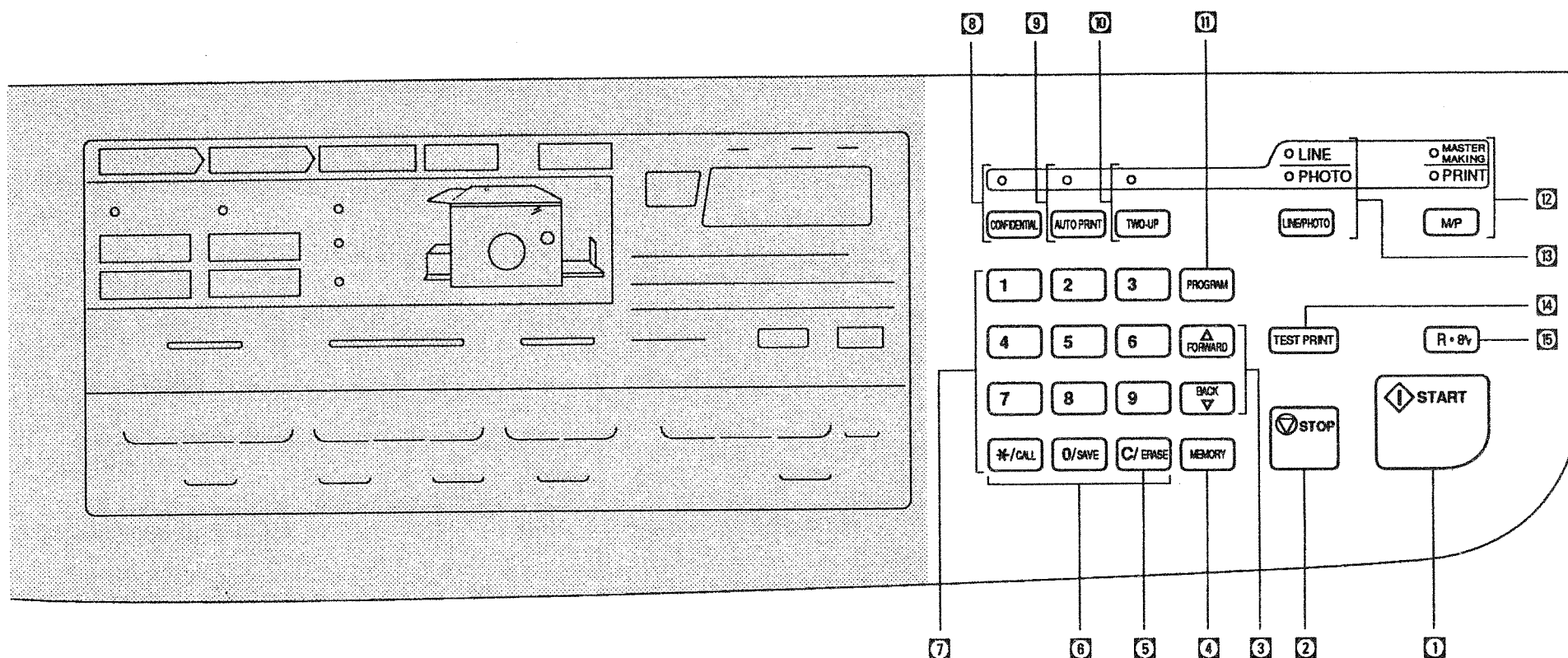

## Using the Control Panel

### Main Panel

#### 1 START Button

Starts printing or making a master. This button is also used to resume operation after troubleshooting.

#### 2 STOP Button

Interrupts printing.

#### 3 FORWARD and BACK Buttons (Pages 31 and 36)

Provides access to programmed printing items or items in memory for registration in memory or confirmation of settings.

#### 4 MEMORY Button (Page 36)

Provides access to the Memory features.

#### 5 Clear (C) Key

Cancels the number entered and resets the Print Quantity Display to zero.

#### 6 CALL, SAVE, and ERASE Buttons (Page 36)

Recalls, saves, or deletes settings in memory.



**7 Print Quantity Keys**

Use these keys to enter the number of copies to be printed, or to enter other numeric values.

**8 CONFIDENTIAL Button (Page 26)**

Protects confidential documents from unauthorized duplication. The indicator lights when the feature is active.

**9 AUTO PRINT Button (Page 27)**

Automates the process of master-making through printing. The indicator lights when the feature is active.

**10 TWO-UP Button (Page 28)**

Reproduces two prints side by side on one sheet of paper. The indicator lights when the feature is active.

**11 PROGRAM Button (Page 31)**

Provides access to programmed grouping of prints.

**12 Master-Making/Print (M/P) Button**

Switches between Master-Making and Printing operations. Normally, selection is automatically made according to the current process.

**13 LINE/PHOTO Selection Button (Page 20)**

Switches the current mode between Line and Photo processing. The indicators light when the feature is active.

**14 TEST PRINT Button (Page 21)**

Prints a sample from the current master. This button can be used to check print quality, printing position, density, and so on.

**15 ALL RESET Button**

Returns all settings to initial status. This button is also used to clear error messages after troubleshooting.





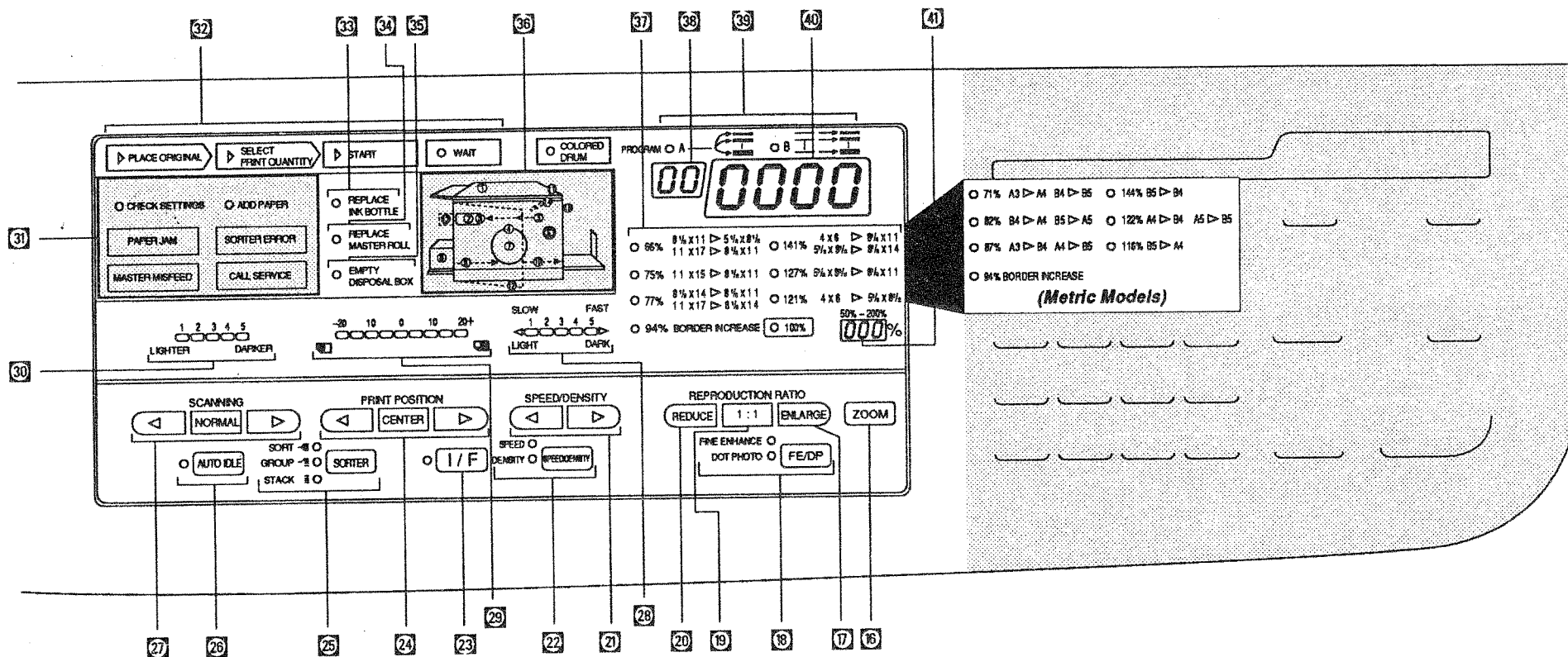

### Sub Panel

- 16 PRESET RATIO/ZOOM Selection Button (Page 22)**  
Switches between the preset ratios and zoom ratios.
- 17 ENLARGE Button (Page 22)**  
Selects any of three preset enlargement ratios or increases the zoom ratio.
- 18 Image Processing Selection Button (Page 20)**  
Selects either the Fine Enhance or Dot Photo processing feature. The Fine Enhance feature prints small characters or fine lines clearly. The Dot Photo feature processes a photo original with a dot screen. The indicators light when the feature is active.
- 19 1:1 Button (Page 22)**  
Returns the reproduction ratio to 1:1 (100%).
- 20 REDUCE Button (Page 22)**  
Selects any of four reduction ratios or decreases the zoom ratio.
- 21 PRINT SPEED/DENSITY Adjustment Buttons (Page 25)**  
Adjusts print speed or printing density.
- 22 PRINT SPEED/DENSITY Selection Button (Page 25)**  
Selects either print speed or printing density mode. The indicators light when the mode is active.



- 23 INTERFACE (I/F) Button**  
Allows data transmission between the RA4900 and external equipment, such as personal computers, word processors, and so on.
- 24 PRINT POSITION Adjustment Buttons (Page 24)**  
Adjusts vertical print position.
- 25 SORTER Button (Page 54)**  
Use this button when you use the optional sorter. The indicator lights when the sorter is active.
- 26 AUTO IDLE Button (Page 39)**  
When switched ON, extremely light or blurred printing is prevented after the machine is not used for long periods. The indicator lights when AUTO IDLE is switched ON.
- 27 SCANNING Contrast Adjustment Buttons (Page 21)**  
Selects any of five contrast adjustments for the darkness of the original to be scanned.

### *Panel Displays*

- 28 Print Speed/Density Display**  
Shows the selected print speed or printing density.
- 29 Print Position Display**  
Shows the current print position.
- 30 Original Scanning Contrast Display**  
Shows the current original scanning contrast.
- 31 Check & Error Display**  
Shows errors or machine status.
- 32 Operation Status Display**  
Shows the next operation.
- 33 Replace Ink Bottle Display**  
Flashes when ink bottle is empty.
- 34 Replace Master Roll Display**  
Flashes when the Master Roll is depleted.

- 35 Empty Disposal Box Display**  
Flashes when the Master Disposal Box is full.
- 36 Machine Monitor Display**  
Shows locations associated with errors, advisory messages on the Print Quantity Display, or machine settings.
- 37 Preset Reduction/Enlargement Ratio Display**  
Shows the current preset reduction or enlargement ratio.
- 38 Entry Number Display**  
Shows programmed printing entries or Memory Register Numbers. Reduction or enlargement, continuous printing, Two-Up printing, Program A or B, and print density can be registered to memory as a single entry number.
- 39 Program Display**  
Shows the selected Program setting (A or B).
- 40 Print Quantity Display**  
Shows the specified number of copies to be printed or advisory messages.
- 41 Zoom Ratio Display**  
Shows the selected zoom ratio.



## About Printing Paper

### Selecting Printing Paper

Printing paper sizes of 4 x 6 inch (postcard size, or A6) to 11 x 17 inch (ledger size, or A3) can be used. A wide range of paper thicknesses and types can be used for printing. Use printing paper with weights in the range of 13-lb bond (46 g/m<sup>2</sup>) to 110-lb index (210 g/m<sup>2</sup>).

The maximum printing area is 7.8 x 13.7 inch for a legal Drum Unit and 245 x 350 mm for a B4 Drum Unit.

#### Important!

**Do not use the following paper, which can cause a jam or misfeed:**

- Extremely thin paper (less than 13-lb bond, or 46 g/m<sup>2</sup>)
- Extremely thick paper (greater than 110-lb index, or 210 g/m<sup>2</sup>)
- Chemically treated paper (such as thermal paper, carbon paper)
- Wrinkled, curled, folded, or torn paper
- Chemically coated paper (one or both sides)
- Paper with folded, curled, or rough leading edges
- Heavy drawing paper

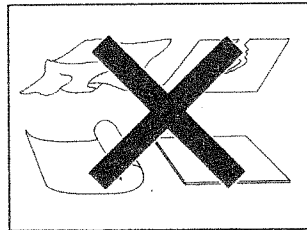

#### To prevent paper jams and misfeeds:

- When using standard paper, set the Paper Feed Pressure Adjustment Lever to "NORMAL" and the Paper Guiding Arms to "Standard". ➔ **Pages 14-15**
- When using thick paper, such as drawing paper, set the Paper Feed Pressure Adjustment Lever to "CARD" and the Paper Guiding Arms to "Thick Paper/Ledger Paper". ➔ **Pages 14-15**
- When using ledger-size (A3) size paper, set the the Paper Guiding Arms to "Thick Paper/Ledger Paper". ➔ **Page 15**
- When using slippery paper, set the Paper Feed Pressure Adjustment Lever to "CARD". ➔ **Page 15**
- Slide the Feed Tray Paper Guides, Receiving Tray Paper Guides, and Paper Stop to fit the paper size. ➔ **Pages 14-15**
- Use flat printing paper that is free of folds. If curled paper is unavoidable, place the printing paper so that the curl faces down.
- Printing paper tends to stick to the drum surface if the top margin is too narrow on the original or if the upper portion of the original uses a large amount of ink. To solve this problem, lower the print position to provide a wider top margin or reverse the top and bottom of the original. Then restart printing from the beginning. ➔ **Page 24**

### Storing Paper

Store printing paper in a level, dry area. Storing the paper in a humid area could cause paper jams and/or poor print quality.

After unpacking printing paper, keep remaining paper wrapped and store it in a moisture-proof box. It is highly recommended to put silica gel in the paper storage box.



## About Your Originals

You can use originals from 4 x 6 inch (postcard size, or A6) size to 11 x 17 inch (ledger size, or A3). The weight of originals should be between 15-lb bond (50 g/m<sup>2</sup>) and 32-lb bond (120 g/m<sup>2</sup>).

You can use the LINE/PHOTO button to produce printed copies according to the contents of the original. If the original contains only text or lines, select LINE to produce crisp characters. If the original contains photos, select PHOTO to reproduce different shades.

In addition, you can use the Image Processing Selection button to select FINE ENHANCE or DOT PHOTO. Fine Enhance prints small characters and fine lines clearly, and Dot Photo processes a photo original with a dot screen.

Be sure to provide a margin of  $\frac{3}{8}$  inch (10 mm) or more at the top of an original.

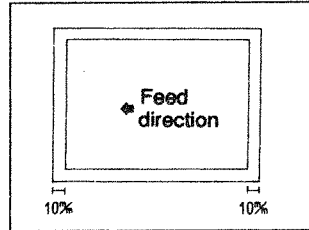

### Use the carrier sheet when printing the following originals:

- Patched or worn originals
- Wrinkled, curled, folded, or torn originals
- Transparent originals (such as tracing paper, OHP transparency)
- Originals that are chemically coated (one or both sides)
- Originals with correction fluid or glue. If correction fluid or glue is used on an original, thoroughly dry it before you set the original in position.
- Originals with folded, curled, or rough leading edges
- Heavy drawing paper
- Extremely thin originals (less than 15-lb bond, or 50 g/m<sup>2</sup>)
- Originals with a chemically treated surface (such as thermal paper or carbon paper)

### **Important!**

#### **Do not use the following originals:**

- Originals with staples or clips
- Extremely thick originals (greater than 32-lb bond, or 120 g/m<sup>2</sup>)





## Quick Overview

Printing operations are divided into three stages: Setting up and loading the Paper Feed Tray and Paper Receiving Tray, making masters, and printing.

## Setting Up

### 1 Open the Original Tray.

➔ *Page 18*

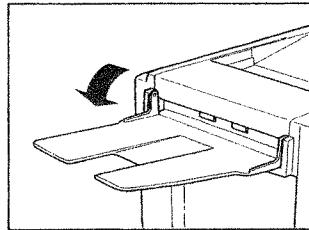

### 2 Open the Paper Feed Tray, load paper, and adjust the Feed Tray Paper Guides.

➔ *Page 14*

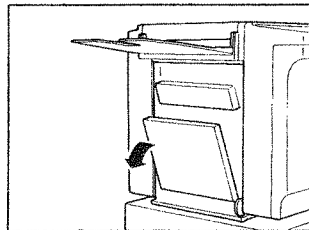

### 3 Open the Paper Receiving Tray and raise the Receiving Tray Paper Guides and Paper Stop.

➔ *Page 15*

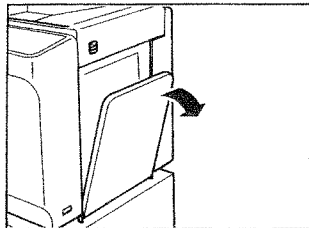

### 4 Turn the power ON and check the Operation Status Display.

➔ *Page 16* — An optional colored-ink Drum Unit can be installed.

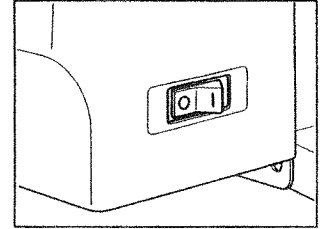

## Making Masters

When you make the master, you can change settings to optimize print quality.

➔ *Page 36* — All settings can be saved in memory for quick recall.

### 5 Place originals face-down on the Original Feed Table.

➔ *Page 18*

➔ *Page 21* — Scanning contrast can be adjusted.

➔ *Page 20* — The type of processing (line, photo, fine enhancement, or dot photo) can be specified.

➔ *Page 22* — Reproduction ratio (print size) can be specified.

➔ *Page 27* — The Auto Print feature can be switched ON.

➔ *Page 28* — The Two-Up feature can be activated.

➔ *Page 31* — The Programmed Printing feature can be activated.

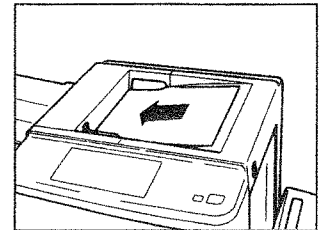



**6 Press the START button.**

A sample print is automatically produced.

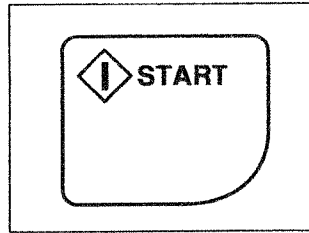

**7 Check print quality.**

- **Page 24** — Print position can be adjusted vertically and horizontally.
- **Page 25** — Print speed or printing density can be adjusted.
- **Page 21** — More sample prints can be printed.

## Printing

**8 Enter the number of copies to be printed.**

- **Page 19**

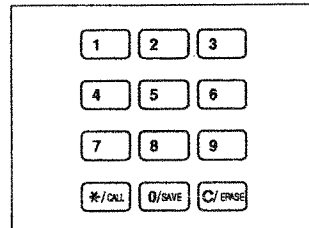

**9 Press the START button.**

The specified number of copies are printed.

- **Page 19**
- **Page 26** — After printing, the master remains on the Drum Unit unless the Confidential feature is switched ON.

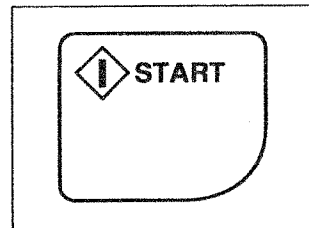



## Setting Up the Paper Feed Tray

### 1 Open the Paper Feed Tray.

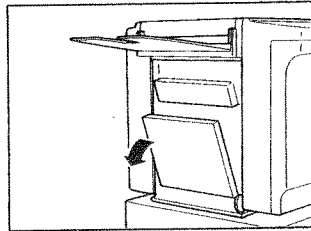

### 2 Load printing paper and slide the Feed Tray Paper Guides to fit the paper width.

#### **Important!**

Do not mix printing paper of different sizes.

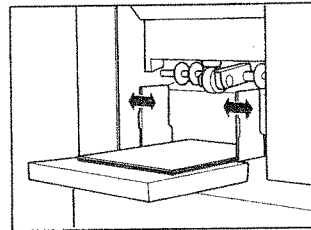

### 3 Set the paper feed pressure.

Position the Paper Feed Pressure Adjustment Lever at either Normal or Card, according to the paper to be used:

- **NORMAL**  
— when using standard paper
- **CARD**  
— when using thick paper, such as drawing paper, or slippery paper

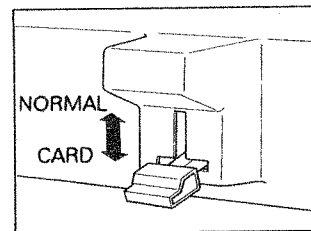

## Replacing or Adding Paper

If printing paper is depleted during printing, or you want to use paper of a different size, lower the Paper Feed Tray so that you can load the paper easily.

To lower the Paper Feed Tray, hold down the Feed Tray Down button.

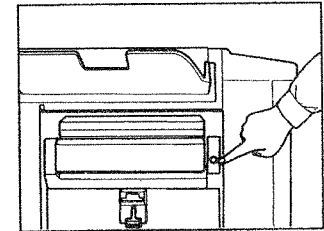

#### **Important!**

Do not mix different paper sizes in the Paper Feed Tray.

## Closing the Paper Feed Tray

Remove the printing paper, widen the Feed Tray Paper Guides completely, and then close the Paper Feed Tray.

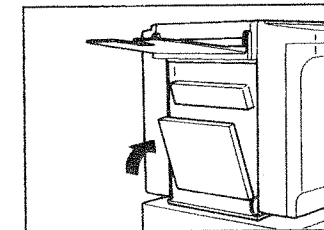



## Setting Up the Paper Receiving Tray

Printed paper stacks on the Paper Receiving Tray according to size, thickness, and quantity. The Paper Receiving Tray can be positioned at high and low levels:

- At the high level, the tray is angled.
- At the low level, it can be level or angled.

Choose the best Paper Receiving Tray position for the paper you are using.

### 1 Open the Paper Receiving Tray.

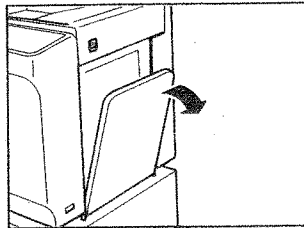

### 2 Raise and slide the Receiving Tray Paper Guides to fit paper width.

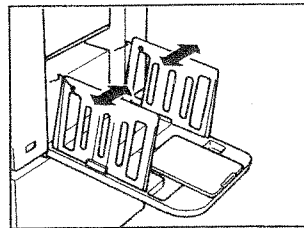

### 3 Adjust the Paper Guiding Arms.

Adjust the Paper Guiding Arms so that discharged paper stacks easily.

- For standard paper, lower the Paper Guiding Arms and set them in the slit of the Receiving Tray Paper Guides.
- For card stock and ledger-size (A3) paper, raise the Paper Guiding Arms.

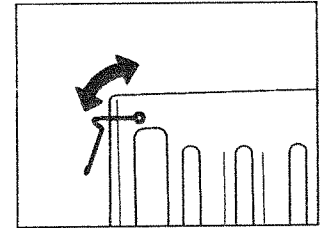

### 4 Raise and slide the Paper Stop to fit paper length.

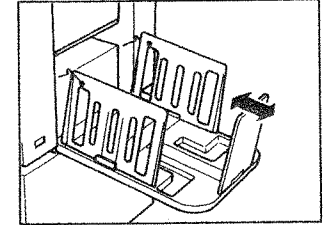

## Closing the Paper Receiving Tray

Slide the Paper Stop to the ledger (A3) position and turn it down. Spread the Receiving Tray Paper Guides to the ledger (A3) position, turn them down, and close the Paper Receiving Tray.

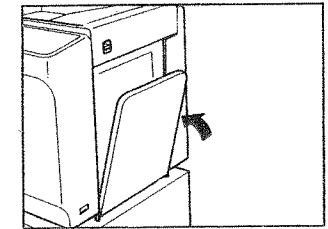





## Color Printing

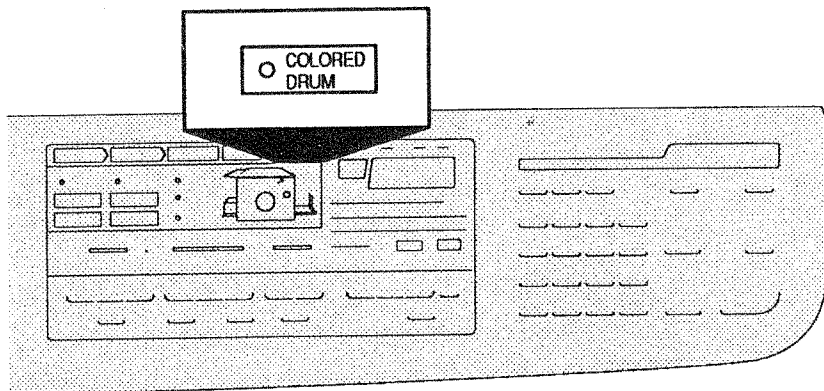

To print with another color ink, purchase optional color Drum Units and replace the entire drum. When a Drum Unit other than black is in place, the COLORED DRUM indicator lights on the control panel.

### Caution

**Always use RISOGRAPH RA Drum only.**

**Notes** Change Drum Units with the power ON.

Store the removed Drum Unit horizontally in the Drum Unit case.

Never store Drum Units in an upright position.

## Changing Color Drum Units

### 1 Open the Front Cover.

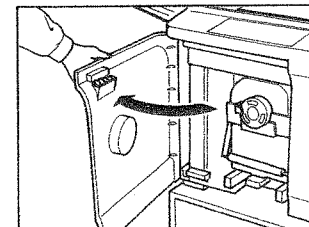

### 2 Be sure that the Drum Home Position indicator is lit.

If it is not lit, press the Drum Home Position indicator. The drum will rotate and stop at the preset home position, and the Drum Home Position indicator will light.

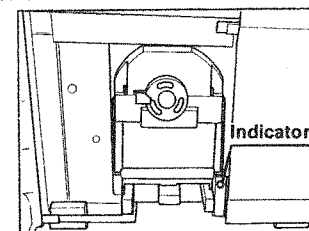

**Note** Unless the Drum Home Position indicator is lit, the Drum Unit cannot be pulled out.

### 3 Pull out the Drum Unit.

Raise the Drum Unit Handle until it is level and pull out the Drum Unit until it stops.

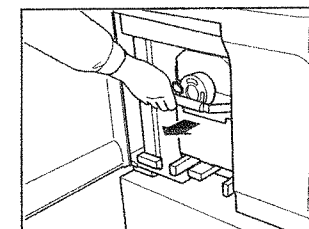

### 4 Remove the Drum Unit from the machine.

Lift the Drum Unit with both hands and remove it from the machine.

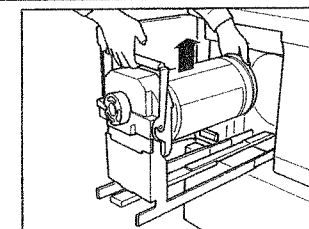



**5 Load the color Drum Unit onto the holder.**

Insert the Drum Unit into the holder horizontally, holding the handle and body with both hands.

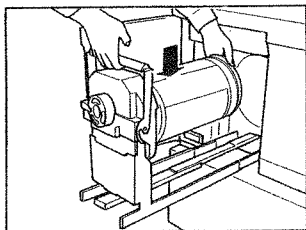

**6 Install the Drum Unit in the machine.**

With the Drum Unit Handle in its raised position, push the Drum Unit into the machine until it stops. Then lower the handle and close the Front Cover.

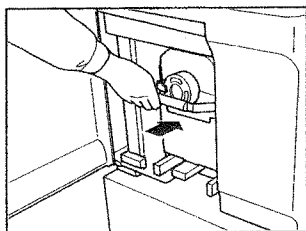



## Making Masters and Printing

### **⚠ WARNING – To Avoid Personal Injury**

- Be alert and use common sense.
- Don't open the covers or move the machine during operation.
- Keep loose clothing away from moving parts to avoid becoming entangled.
- Keep hands away from openings in the machine during operation.
- Before cleaning any parts of the machine, turn the power OFF.
- Disconnect the power cord if you think an electrical problem is present.

### **⚠ Caution – To Avoid Mechanical Problems**

- Open/close the covers gently.
- Do not turn the power switch OFF or pull out the power cord during operation.
- DO NOT place items on top of the machine or in any opening of the machine during operation. This could damage the machine.

### **1 Turn the power switch ON.**

The power switch is located on the lower right side of the machine:

- I - ON
- O - OFF

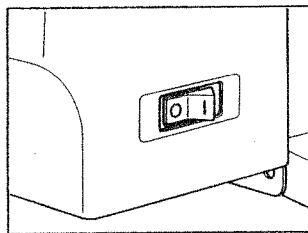

### **2 Check the settings on the control panel.**

When power is connected, the indicators on the control panel show the initial settings. Make any necessary changes such as reproduction ratio, LINE/PHOTO, and so on.

**Holding down the R • 8r (ALL RESET) button for more than 1 second returns the control panel to the initial settings.**

- ➔ **Page 39** — Return to initial settings.
- ➔ **Page 40** — You can customize the initial settings.
- ➔ **Page 36** — Frequently used combinations of settings can be saved in memory for quick recall.

### **3 Open the Original Tray.**

Rotate the Original Tray, folded on the ADF Unit, by 180° outward.

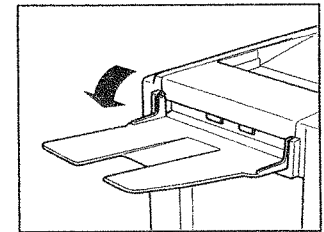

### **4 Place originals on the Original Feed Table.**

Adjust the Original Guides to the width of the originals. Then insert the originals face down into the ADF Unit until they stop. The originals are automatically fed and set into place.

A maximum of 50 originals can be set into place at one time.

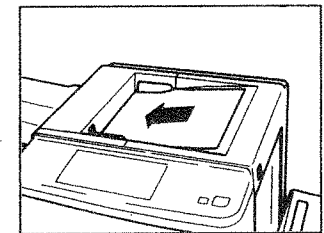

**Note** When originals are in place, processing automatically changes to Master-Making from Printing. The MASTER-MAKING indicator on the control panel lights.



**5 Press the START button.**

After an original is scanned, a master is created. A sample is automatically printed so that you can check the print quality, position, and density.

➔ **Page 24** — To change the position of the printed image, press the PRINT POSITION adjustment buttons, and/or turn the Left/Right Print Position Adjustment Dial.

➔ **Page 25** — To change printing density of the printed copies, change the Printing Density setting.

If settings are changed, press the TEST PRINT button to check the results with sample prints.

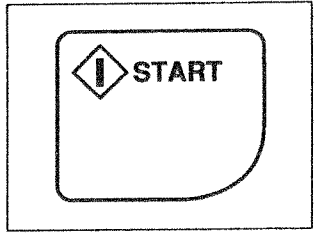

**6 Enter the number of copies to be printed.**

Specify the number of copies to be printed using the Print Quantity keys. The specified number is displayed on the Print Quantity Display.

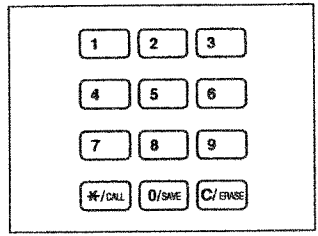

**Note** If you enter the incorrect number, press the C/ERASE key to reset the Print Quantity Display to zero, then enter the correct number.

**7 Press the START button.**

The specified number of copies are printed.

**Note** If printing stops and the ADD PAPER indicator flashes on the control panel, paper in the Paper Feed Tray is depleted. Load paper into the Paper Feed Tray.

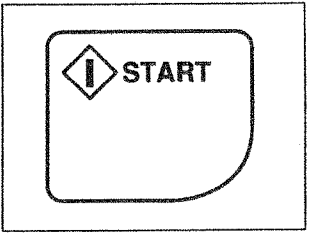





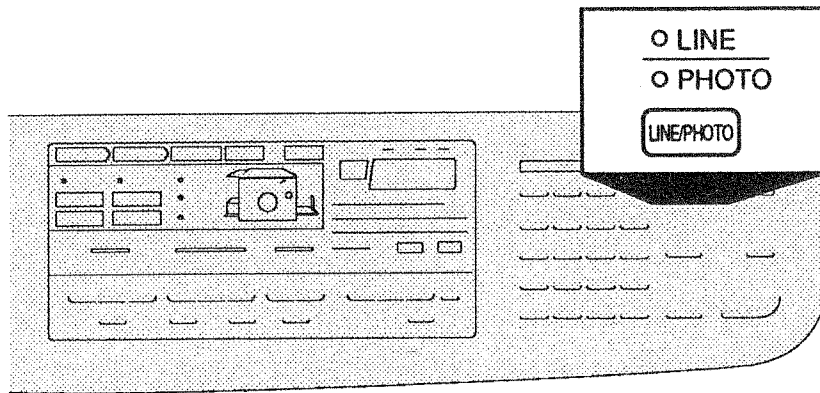

## Standard Text/Photo Processing

You can produce printed copies that are processed according to the contents of the original.

Holding down the LINE/PHOTO button switches between LINE and PHOTO.

➔ **Page 20** — For enhanced processing, use the Image Processing selection button.

### Line

- Select LINE if the original contains only text or lines. This includes word-processed originals, photocopies, and newspaper. Since images are processed in two scales, characters are sharply defined.

### Photo

- Select PHOTO if your original contains a photo. Since it will be graphically processed, degrees of shading are accurately reproduced.

**Note** If LINE is selected to print an original that contains a photo with dark shades, copies could be smudged.

**Holding down the R • 8v (ALL RESET) button for more than 1 second returns processing to the initial setting (LINE).**

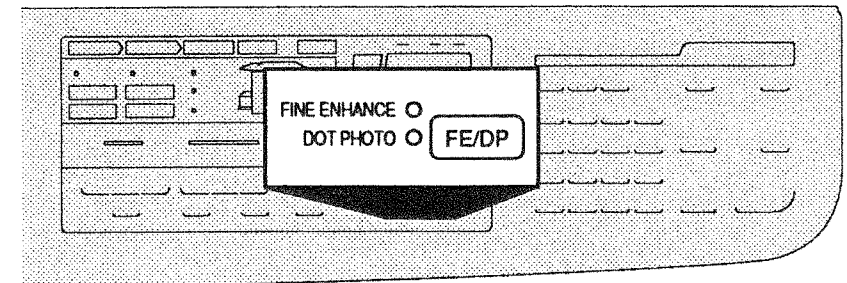

## Enhancing Print Processing

You can select enhanced print processing when the original has very small characters and/or fine lines or when the original is a photo.

Press the Image Processing selection button to select either FINE ENHANCE or DOT PHOTO. When FINE ENHANCE or DOT PHOTO is selected, the corresponding indicator lights.

### Fine Enhance

- Select FINE ENHANCE to print small characters and fine lines clearly. This feature can be used for originals containing lines and/or photos.

### Dot Photo

- Select DOT PHOTO to process a photo original with a dot screen. This feature can be used only for photo originals.

**Holding down the R • 8v (ALL RESET) button for more than 1 second returns processing to the initial setting.**



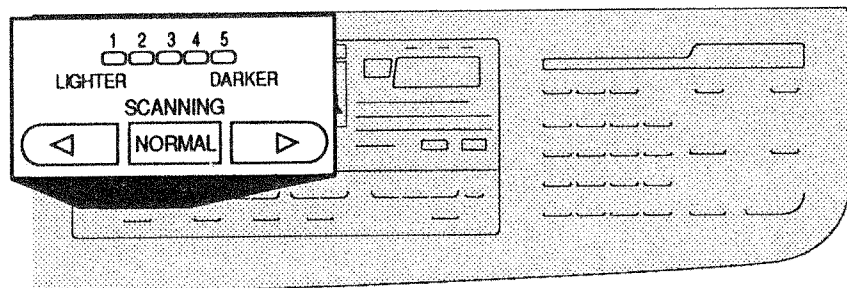

## Adjusting Scanning Contrast

Scanning contrast can be set to any of five levels according to the darkness of the original.

- For light originals, such as inappropriately copied documents or those written with a pencil, make the scanning contrast darker.
- For dark originals, like newspapers or colored stock, make the scanning contrast lighter.

Use the SCANNING Contrast Adjustment buttons as follows:

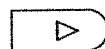
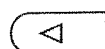
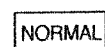
-  Makes the contrast darker.
-  Makes the contrast lighter.
-  Returns the contrast to normal.

**Holding down the R • 8v (ALL RESET) button for more than 1 second returns the contrast to the initial setting (NORMAL).**

➔ **Page 36** — Scanning contrast can be adjusted and saved in memory for quick recall.

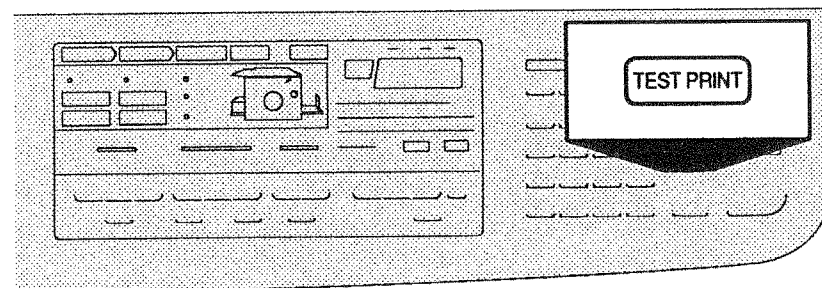

## Checking Print Quality

If changes have been made to print position, etc., check print quality by producing test prints.

If you hold down the TEST PRINT button, you can print continuously.

Test printing does not affect the quantity in the Print Quantity Display.



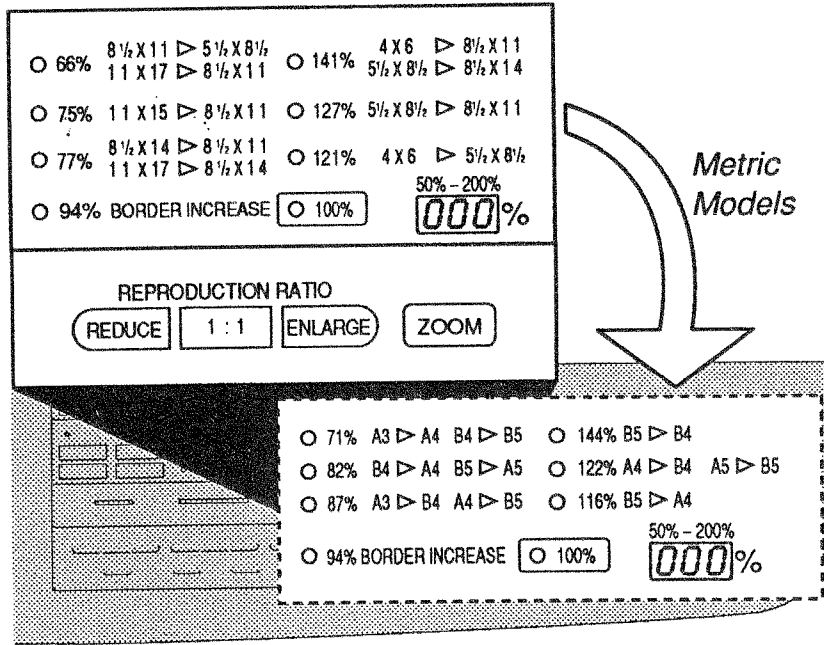

## Reducing or Enlarging Originals

Originals can be reduced or enlarged in either of two ways: Preset ratios or zoom ratios that you specify.

Press the PRESET RATIO/ZOOM selection button to select the method that you want to use. Each time that the PRESET RATIO/ZOOM selection button is pressed, the method switches between Preset Ratio and Zoom Ratio.

Indicators on the control panel show the method currently selected:

- When any of the Preset Ratio indicators are lit, you can use the Preset Ratio method to reduce or enlarge. All seven preset ratios are shown on the control panel.
- When the Zoom Ratio Display is lit, you can specify the percentage for reduction or enlargement, ranging between 50% and 200%.

➔ **Page 36**— Reproduction ratios can be adjusted and saved in memory for quick recall.

## Using Preset Ratios

To reduce or enlarge any standard-size original to another standard size, use the Preset Ratio method. When any of the Preset Ratio indicators are lit, you can use the Preset Ratio method to reduce or enlarge. All seven preset ratios are shown on the control panel.

When the Preset Ratio method is selected, an original can be printed in any of four standard reduced sizes or three standard enlarged sizes.

### USA Model

■ Reduce to:

- 94% Border increase
- 77% 8 1/2 x 14 ▶ 8 1/2 x 11  
11 x 17 ▶ 8 1/2 x 14
- 75% 11 x 15 ▶ 8 1/2 x 11
- 66% 8 1/2 x 11 ▶ 5 1/2 x 8 1/2  
11 x 17 ▶ 8 1/2 x 11

■ Enlarge to:

- 121% 4 x 6 ▶ 8 1/2 x 11
- 127% 5 1/2 x 8 1/2 ▶ 8 1/2 x 11
- 141% 4 x 6 ▶ 8 1/2 x 11  
5 1/2 x 8 1/2 ▶ 8 1/2 x 14

### Metric Models

■ Reduce to:

- 94% Border increase
- 87% A3 ▶ B4, A4 ▶ B5
- 82% B4 ▶ A4, B5 ▶ A5
- 71% A3 ▶ A4, B4 ▶ B5

■ Enlarge to:

- 116% B5 ▶ A4
- 122% A4 ▶ B4, A5 ▶ B5
- 144% B5 ▶ B4

**1 Confirm that the Zoom Ratio Display is not lit.**

If the Zoom Ratio Display is lit, press either the PRESET RATIO/ZOOM selection button or the 1:1 button to activate the Preset Ratio indicators.

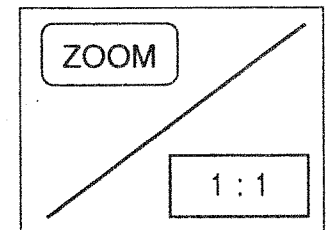



**2 Press the REDUCE or ENLARGE button to select the desired ratio.**

- Each time the REDUCE button is pressed, the indicators light in this order: 94% – 77% – 75% – 66% – 94% (94% – 87% – 82% – 71% – 94% for metric models).
- Each time the ENLARGE button is pressed, the indicators light in this order: 121% – 127% – 141% – 121% (116% – 122% – 144% – 116% for metric models).

When you press the 1:1 button, the ratio returns to the original size (100%).

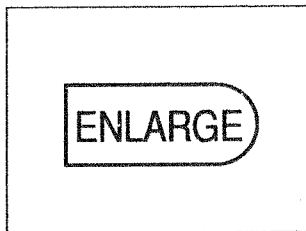
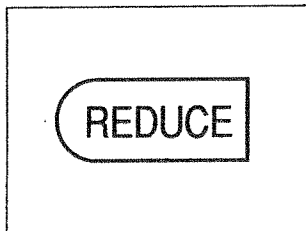

**Holding down the R • 8v (ALL RESET) button for more than 1 second returns print size to the initial setting (1:1).**

### Using Zoom Ratios

You can specify any reduction or enlargement ratio between 50% and 200%.

**Note** When you press the 1:1 button, the Zoom Ratio Display is turned off and the ratio returns to the original size (100%).

**1 Confirm that the Zoom Ratio Display is lit.**

If a Preset Ratio indicator is lit, press the PRESET RATIO/ZOOM selection button until the Zoom Ratio Display lights.

The current reproduction ratio is shown in the Zoom Ratio Display.

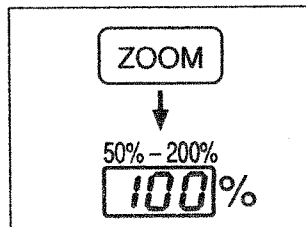

**2 Press the REDUCE or ENLARGE button to specify the desired ratio in the Zoom Ratio Display.**

- Each time you press the REDUCE button, the percentage in the Zoom Ratio Display decreases by 1%. When you hold down the button for more than 1 second, the displayed percentage decreases continuously.
- Each time you press the ENLARGE button, the percentage in the Zoom Ratio Display increases by 1%. When you hold down the button for more than 1 second, the displayed percentage increases continuously.

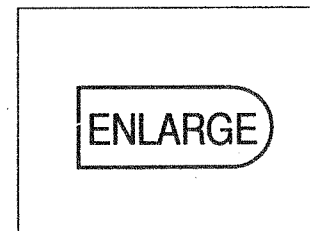
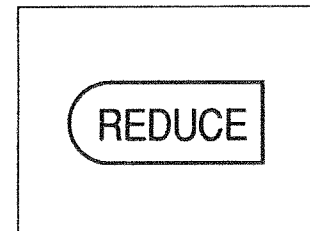

**Holding down the R • 8v (ALL RESET) button for more than 1 second returns print size to the initial setting (1:1).**





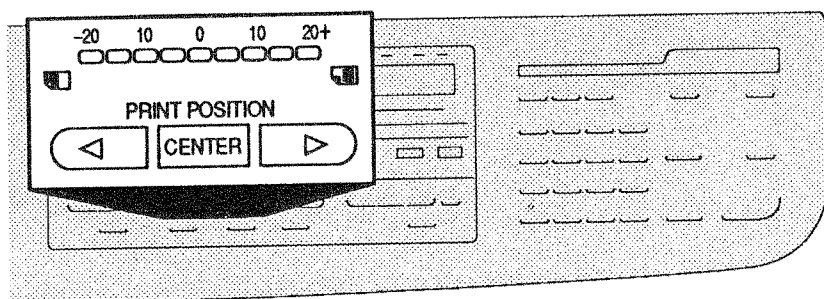

## Positioning the Print

Print position can be adjusted up and down and/or right and left:



- Vertical print position can be adjusted by pressing the PRINT POSITION Adjustment buttons on the control panel.
- Horizontal print position can be adjusted by using the Left/Right Print Position Adjustment dial on the Paper Feed Tray.

**Note** *If you adjust the print position, be sure to produce test prints to verify the new print position.*

*Printing paper can stick to the drum surface if the top margin is too narrow on the original or if the upper portion of the original uses a large amount of ink. To solve this problem, lower the print position to provide a wider top margin or reverse the top and bottom of the original and restart printing from the beginning.*

## Adjusting Vertical Print Position

You can move the print position up or down within a range of  $\pm 3/4$  inch ( $\pm 20$  mm) by pressing either of the PRINT POSITION Adjustment buttons.

-  Moves print position down.
-  Moves print position up.
-  Returns print position to the center.

**Holding down the R • 8v (ALL RESET) button for more than 1 second returns the print position to the initial setting (CENTER).**

➔ **Page 36** — The vertical print position can be adjusted and saved in memory for quick recall.

## Adjusting Horizontal Print Position

You can move the print position left or right by turning the Left/Right Print Position Adjustment dial on the Paper Feed Tray.

The distance that you can adjust horizontal print position is determined by the size of the printing paper:

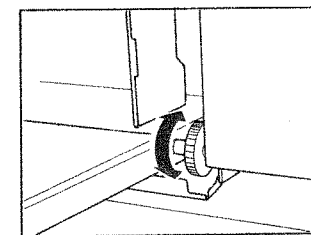

- |                              |   |                               |
|------------------------------|---|-------------------------------|
| 4 x 6 inch (postcard, or A6) | ▶ | $\pm 3/4$ inch ( $\pm 20$ mm) |
| to 10.1 x 14.3 inch (B4)     | ▶ |                               |
| 11 x 17 inch (ledger, or A3) | ▶ | $\pm 3/16$ inch ( $\pm 5$ mm) |



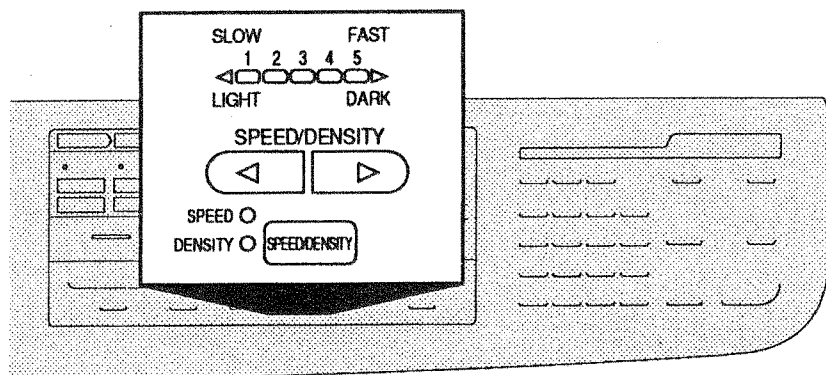

## Adjusting Print Speed or Printing Density

Print speed or printing density can be adjusted using the PRINT SPEED/DENSITY adjustment buttons. Each time that the PRINT SPEED/DENSITY selection button is pressed, the setting switches between SPEED and DENSITY modes. The indicator lights when the mode is active.

- SPEED ● : Set print speed.
- DENSITY ● : Set printing density.

➔ **Page 36** — Print speed or printing density can be adjusted and saved in memory for quick recall.

**Holding down the R•8r (ALL RESET) button for more than 1 second returns print speed and printing density to the initial settings.**

## Adjusting Print Speed

Print speed can be set at any of five levels, ranging between 60 and 130 sheets per minute. Use the PRINT SPEED/DENSITY selection button to switch between SPEED and DENSITY. When the SPEED indicator is lit, you can adjust print speed.

◀ Decreases print speed.

▶ Increases print speed.

**Note** The normal print speed (setting 3) is 100 sheets per minute.

➔ **Page 40** — You can customize initial settings.

## Adjusting Printing Density

Printing density can be set at any of five levels. Use the PRINT SPEED/DENSITY selection button to switch between SPEED and DENSITY. When the DENSITY indicator is lit, you can adjust printing density.

◀ Makes printing density lighter.

▶ Makes printing density darker.

**Note** Print Speed is automatically set to 100 sheets per minute (setting 3) when Printing Density is adjusted.

When the Printing Density setting is adjusted, press the TEST PRINT button to check the results with sample prints.

**Note** If the Printing Density levels do not provide the desired result, adjust scanning contrast and create another master.

➔ **Page 21**



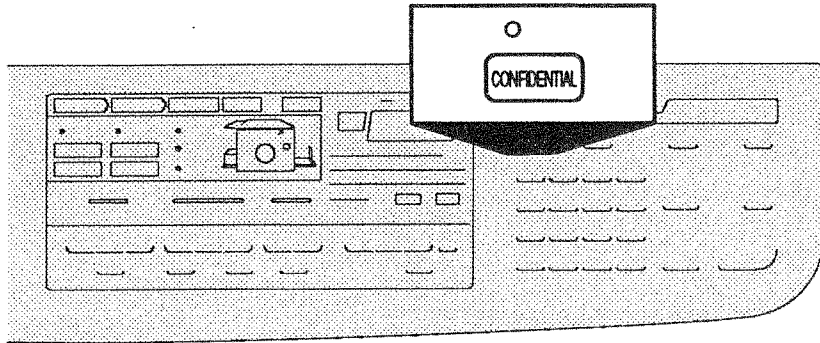

## Protecting Confidential Documents

After printing is complete, the master remains on the Drum Unit. The master on the Drum Unit can be printed at any time by pressing the START button.

To protect confidential documents from duplication, press the CONFIDENTIAL button to discard the original's master after printing.

### 1 Confirm that printing has ended.

### 2 Press the CONFIDENTIAL button.

The CONFIDENTIAL indicator lights.

**Note** To cancel the Confidential feature, press the CONFIDENTIAL button again.

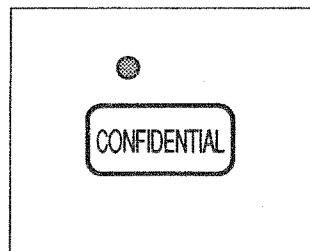

### 3 Press the START button.

The existing master is discarded and replaced with a blank master.

The CONFIDENTIAL indicator goes out, and the Confidential feature is canceled.

**Note** The master is discarded into the Master Disposal Box.

➔ **Page 46** — For strictly confidential documents, discard the contents of the Master Disposal Box.

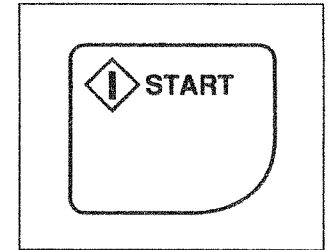



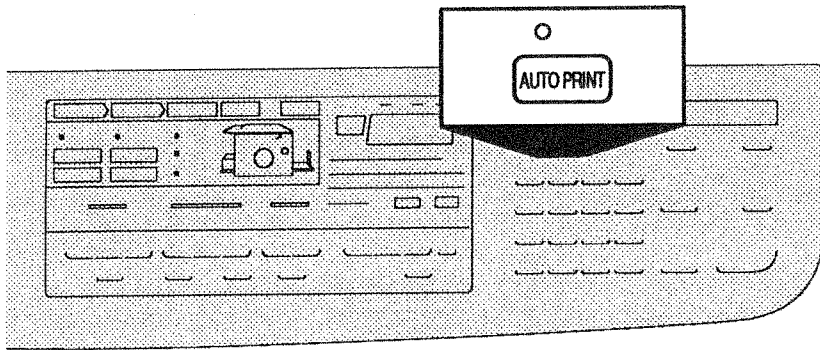

## One-Step Printing

The Auto Print feature automates the processes from master-making through printing.

Press the AUTO PRINT button to activate this feature. To cancel this feature, press the AUTO PRINT button again.

**Note** If you need to check or adjust print position, cancel the Auto Print feature.

### 1 Press the AUTO PRINT button.

The Auto Print indicator lights.

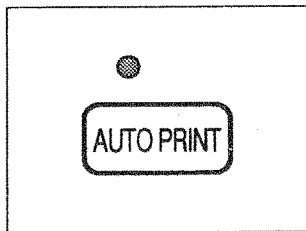

### 2 Set an original into place.

Insert originals face-down into the ADF Unit until they stop. A maximum of 50 originals can be in place at a time.

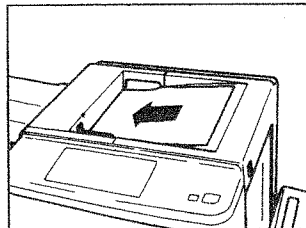

### 3 Enter the number of copies to be printed.

Enter the number of copies to be printed using the Print Quantity keys.

**Note** If you enter an incorrect number, press the C/ERASE key to reset the Print Quantity Display to zero, then enter the correct number.

If zero is displayed as the print quantity, the machine will not start.

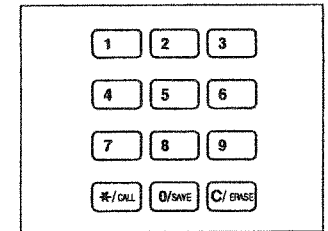

### 4 Press the START button.

Master-making through printing will take place automatically, producing as many copies as specified.

**Note** Since a sample is automatically produced after master-making, one extra copy is printed.

➔ **Page 36** — The Auto Print feature can be saved in memory for quick recall.

**Holding down the R • 8v (ALL RESET) button for more than 1 second returns the Auto Print feature to the initial settings.**

➔ **Page 40** — You can customize initial settings.

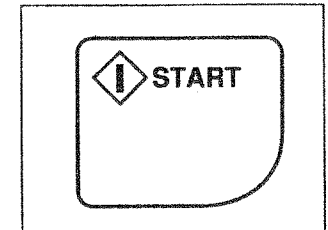





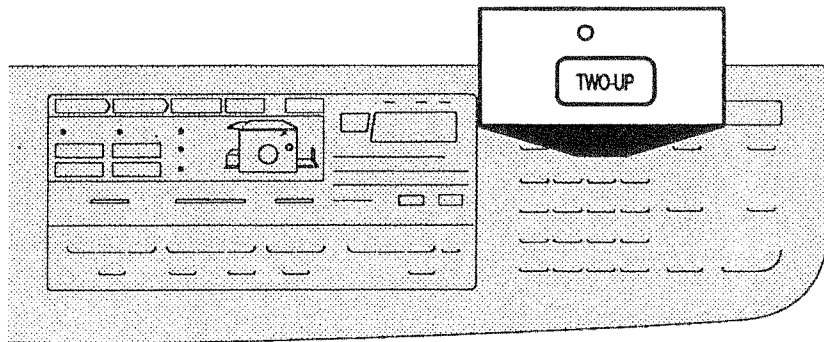

## Printing Two Originals Side by Side

Two of the same, or two different originals can be printed side by side on a sheet using the TWO-UP button.

When printing two originals on a sheet, each original can have different settings for reproduction ratio (Reduce/Enlarge), scanning contrast, and processing (Line/Photo or Fine Enhancement/Dot Photo).

➤ **Page 36** — Frequently used combinations of settings can be saved in memory for quick recall.

High-volume printing time can be cut in half using the Two-Up feature. For example, you can double your productivity by using printing paper that is twice as large as the originals. When you use the Two-Up feature, you can then cut or fold the Two-Up prints in half to finish the job.

■ To print two different originals side by side, using the same combination of settings, place the two originals at one time:

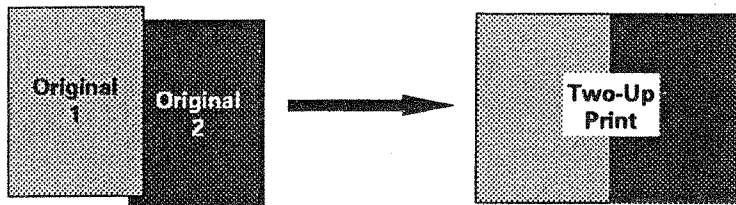

■ To print the same original twice on a sheet, or when different settings are used for two originals, place originals individually:

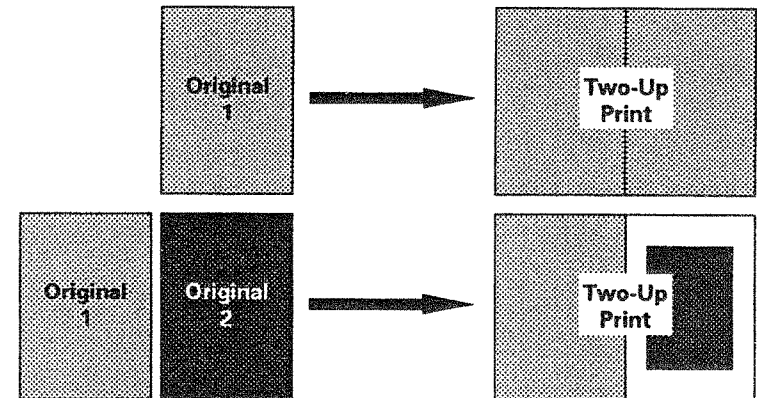

➤ **Page 27** — The Auto Print feature can be used with Two-Up printing.

## Printing Two Different Originals Two-Up

**1** Press the TWO-UP button to activate the Two-Up feature.

The Two-Up indicator lights when the feature is active.

**Note** To cancel the Two-Up feature, press the TWO-UP button again.

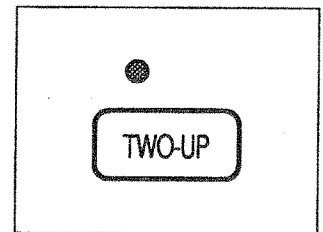



- 2** Place two originals face-down on the Original Feed Table.

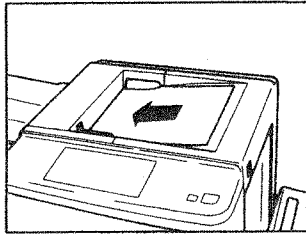

- 3** Press the START button.

The originals are scanned and the Two-Up master is made.

A sample Two-Up print is made.

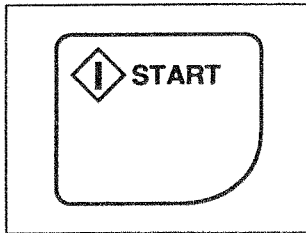

- 4** Enter the number of copies to be printed.

Specify the number of copies to be printed using the Print Quantity keys. The specified number is displayed on the Print Quantity Display.

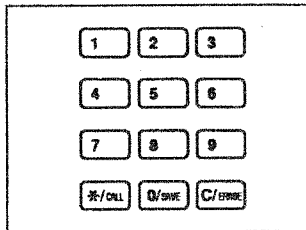

**Note** If you enter the incorrect number, press the C/ERASE key to reset the Print Quantity Display to zero, then enter the correct number.

- 5** Press the START button.

The specified number of Two-Up prints are printed.

The Two-Up indicator goes out, and the Two-Up feature is canceled.

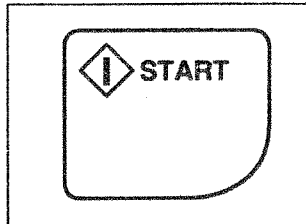

**Note** If more than two originals are placed at one time, the Two-Up feature remains activated after printing is completed.

**Holding down the R • 8v (ALL RESET) button for more than 1 second returns the control panel to the initial settings.**

## Printing the Same Original Twice or Changing Settings for One Original

To print the same original twice on a sheet, or when different settings are used for the two originals, place originals individually.

Each original can have different settings for reproduction size (Reduce/Enlarge), scanning contrast, and processing (Line/Photo or Fine Enhance/Dot Photo).

For Two-Up printing of one original or two originals with different settings, the RISograph scans the first original and then provides a 15-second period for the second original to be placed.

**Note** If you press the STOP button or do not place the second original during the 15-second beep, the sample print is produced with one side blank.

➔ **Page 36** — Frequently used combinations of settings can be saved in memory for quick recall.

- 1** Press the TWO-UP button to activate the Two-Up feature.

The Two-Up indicator lights when the feature is active.

**Note** To cancel the Two-Up feature, press the TWO-UP button again.

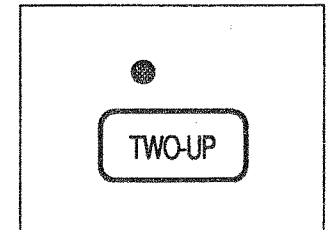



- 2 Place an original face-down on the Original Feed Table.**

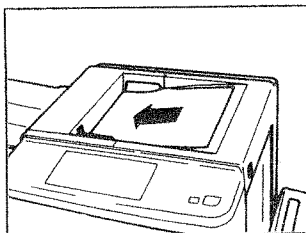

- 3 Press the START button.**

After the first original is scanned and ejected into the Original Tray, a 15-second beep sounds.

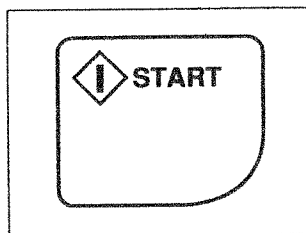

- 4 During the 15-second beep, enter the settings for the second original, if necessary, and place the second original.**

After the second original is scanned, a sample Two-Up print is automatically printed.

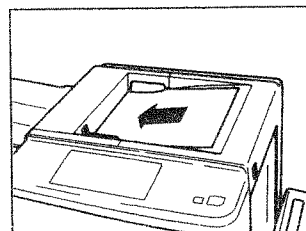

- 5 Enter the number of copies to be printed.**

Specify the number of copies to be printed using the Print Quantity keys. The specified number is displayed on the Print Quantity Display.

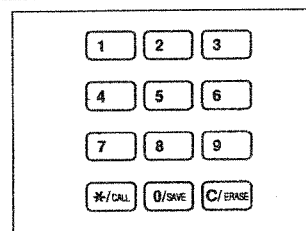

**Note** If you enter the incorrect number, press the C/ERASE key to reset the Print Quantity Display to zero, then enter the correct number.

- 6 Press the START button.**

The specified number of Two-Up copies are printed.

The Two-Up indicator goes out, and the Two-Up feature is canceled.

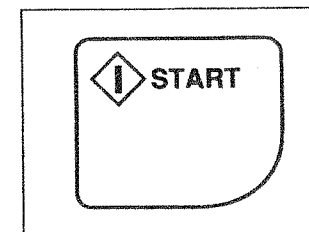

**Holding down the R • 8v (ALL RESET) button for more than 1 second returns the control panel to the initial settings.**



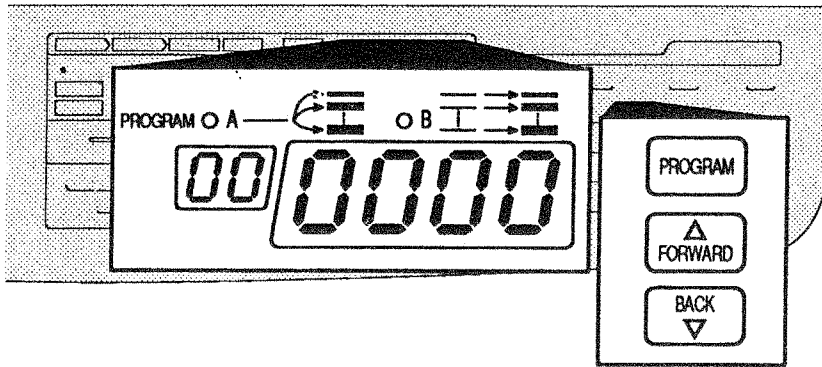

## Automatic Sorting into Groups

The Programmed Printing feature can be used to automatically print and sort printed sheets into various groups. Either of the two programmed printing methods (A or B) can be selected using the PROGRAM button.

Each time you press the PROGRAM button, the indicators change in this order: Program A – Program B – No Program – Program A. Use the PROGRAM button to select either Program A or Program B.

The indicators on the control panel show the method currently selected.

➔ **Page 36** — Frequently used combinations of settings can be saved in memory for quick recall.

**Note** Up to 50 groups can be set up, with a maximum of 9999 copies in each group.

- Program A prints one original in different quantities.

If more than one original (up to 50 sheets) is placed in the ADF unit with the Auto Print feature activated, the program set up for Program A runs completely for each original, until all the originals are printed and sorted into groups as specified in the program.

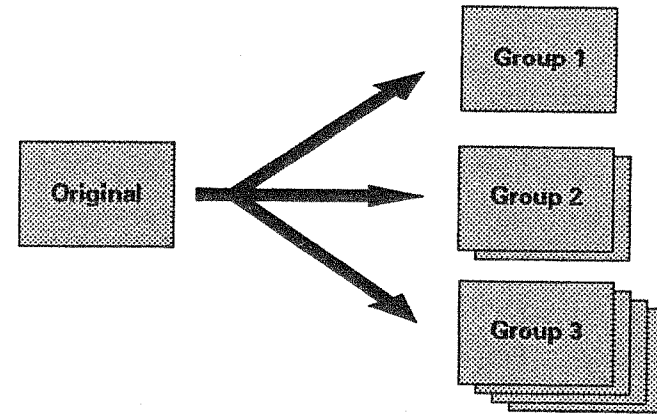

- Program B prints different originals in different quantities.

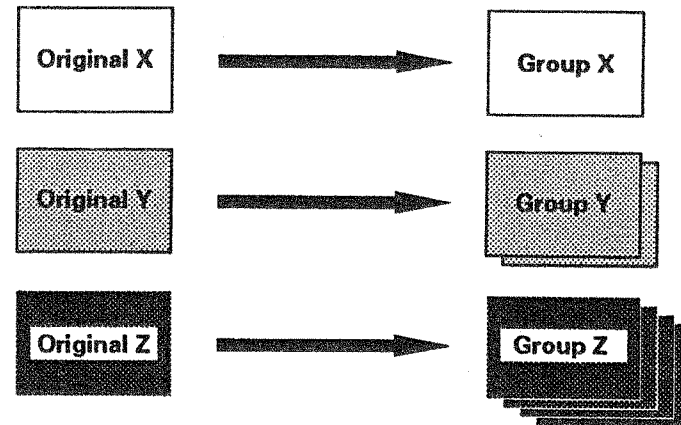





## Setting Up Program A

Select Program A to print different quantities of one original.

➔ **Page 36** — Program A settings can be saved in memory for quick recall.

### 1 Press the PROGRAM button.

The Program A indicator lights and 'A' is shown in the Entry Number Display to identify the first group.

**Note** To cancel Program A, press the PROGRAM button again.

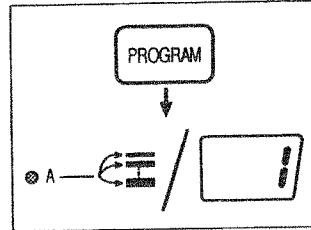

### 2 Set up the number of copies to be printed for the first group using the Print Quantity keys.

**Note** If you enter the incorrect number, press the C/ERASE key to reset the Print Quantity Display to zero, then enter the correct number.

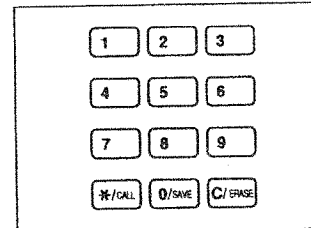

### 3 Press the FORWARD button to set the print quantity for the second group.

The Entry Number Display changes to '2' and the Print Quantity Display is reset to '0'.

➔ **Page 35** — If several groups are to be printed in the same quantity, the quantity can be entered for these groups at one time.

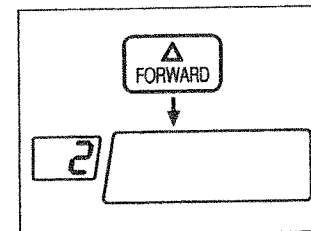

### 4 Set up the number of copies to be printed for the second group.

The specified number is shown on the Print Quantity Display.

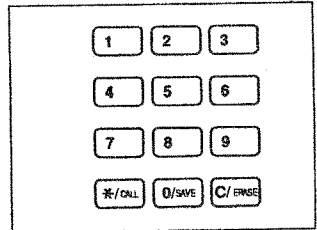

### 5 Use the FORWARD button and Print Quantity keys to set print quantities for the remaining groups.

Up to 50 groups can be specified.

**Note** If the PROGRAM button is pressed before a print quantity is specified for the last group and the START button is pressed, all the Program A settings will be canceled.

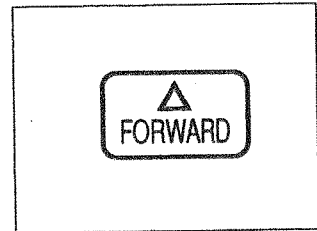

### 6 Press the BACK button to check or correct the number of copies to be printed for any group already set up.

Each time you press the BACK button, the entry number and print quantity for the previous group are displayed.

**Note** If you enter the incorrect number of copies for the displayed group entry number, press the C/ERASE button to reset the Print Quantity Display to zero, then enter the correct number.

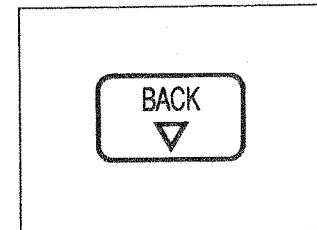



## 7 Enter other settings for Program A.

Specify printing density, printing position, reproduction ratio, and so on. (The Two-Up feature may also be specified.)

**Note** If you want to print more than one original using the same Program A settings, press the AUTO PRINT button to activate the Auto Print feature.

➔ Page 27

➔ **Page 36** — Before pressing the START button, if you use these programmed settings frequently, save the program in memory for quick recall.

## 8 Place the original(s) face-down on the Original Feed Table.

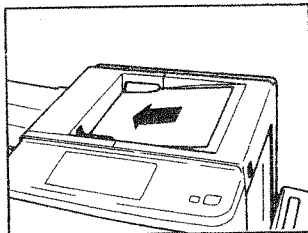

## 9 Press the START button.

A sample print is produced.

If the Auto Print feature is not activated, press the START button again.

Copies are produced and sorted according to the program, starting with the last group specified. When printing is completed, the current Program A settings are automatically cleared.

**Note** If the Auto Print feature is activated, the current Program A settings are returned at the end of printing.

To interrupt the programmed printing, press the STOP button.

**Holding down the R • 8v (ALL RESET) button for more than 1 second returns the control panel to the initial settings and clears the program.**

## Setting Up Program B

Select Program B to print different originals in different quantities.

➔ **Page 36** — Program B settings can be saved in memory for quick recall.

### 1 Press the PROGRAM button twice.

The Program B indicator lights and **!** appears in the Entry Number Display to identify the first original.

**Note** To cancel Program B, press the PROGRAM button again.

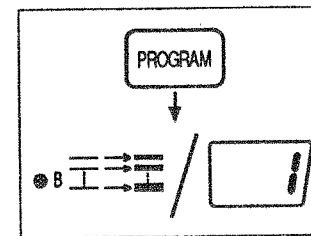

### 2 Set up the number of copies to be printed for the first original using the Print Quantity keys.

**Note** If you enter the incorrect number, press the C/ERASE key to reset the Print Quantity Display to zero, then enter the correct number.

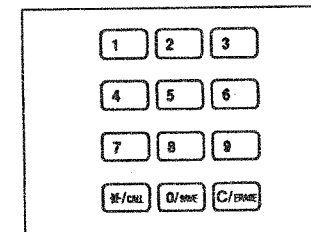

### 3 Press the FORWARD button to set the print quantity for the second original.

The Entry Number Display changes to **2** and the Print Quantity Display is reset to **0**.

➔ **Page 35** — If several originals are printed in the same quantity, the quantity can be entered for these originals at one time.

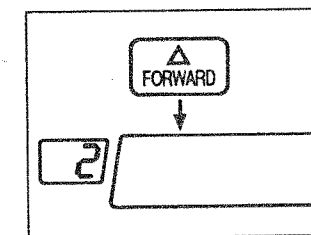



- 4 Set up the number of copies to be printed for the second original using the Print Quantity keys.**

The specified number is shown on the Print Quantity Display.

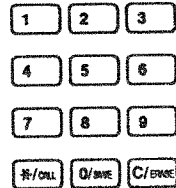

- 5 Set up print quantities for the remaining originals using the FORWARD button and the Print Quantity keys.**

Up to 50 originals can be specified.

**Note** If the PROGRAM button is pressed before a print quantity is specified for the last original and the START button is pressed, all the Program B settings will be canceled.



- 6 Press the BACK button to check or correct the number of copies to be printed for any original already identified.**

Each time you press the BACK button, the entry number and print quantities for the previous original are displayed.

**Note** If you enter the incorrect number of copies for the displayed original entry number, press the C/ERASE button to reset the Print Quantity Display to zero, then enter the correct number.



- 7 Enter other settings for Program B.**

Specify printing density, printing position, and reproduction ratio, and so on. (The Two-Up feature may also be specified.)

➔ **Page 36** — Before pressing the START button, if you use these programmed settings frequently, save the program in memory for quick recall.

- 8 Place the original(s) face-down on the Original Feed Table.**

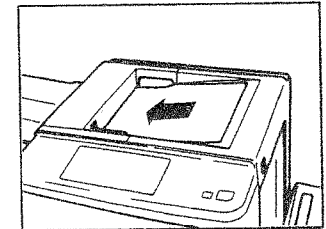

- 9 Press the START button.**

Prints are produced according to the specified program, starting with the last original specified.

When printing is completed, the current Program B settings are automatically cleared.

**Note** To interrupt the programmed printing, press the STOP button.

**Holding down the R • 8v (ALL RESET) button for more than 1 second returns the control panel to the initial settings and clears the program.**

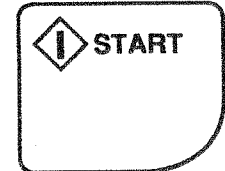



## Programming the Same Quantity for Several Groups

If several groups are to be printed in the same quantity, the print quantity can be entered once. Then, after entering the quantity, you specify the number of groups to be printed in that quantity.

- 1** Press the FORWARD or BACK button repeatedly until the first same-quantity group number is shown on the Entry Number Display.

For example, if groups 41 to 46 have the same print quantity, the first same-quantity group will be "41".

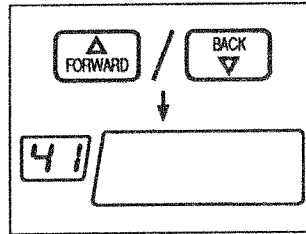

**Note** If another quantity is already entered for the first same-quantity group, press the C/ERASE button to clear the Print Quantity Display.

- 2** Set up the number of copies to be printed using the Print Quantity keys.

**Note** If you enter the incorrect number of copies for the displayed group entry number, press the C/ERASE button to reset the Print Quantity Display to zero, then enter the correct number.

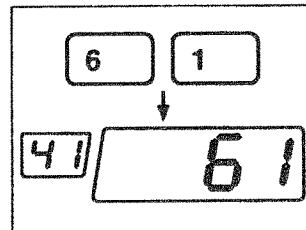

- 3** Press the CALL button.

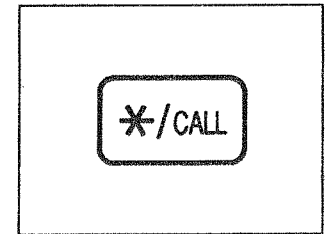

- 4** Enter the number of groups to be printed in the same quantity.

For example, if groups 41 to 46 will be printed in the same quantity, enter "6".

**Note** Enter "1" to cancel the same-quantity group entry.

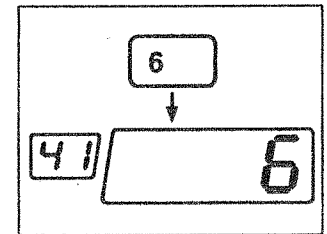

- 5** Press the FORWARD button.

The print quantity is automatically applied to the sequence of groups. The group number following the sequence is shown in the Entry Number Display.

For example, if you entered "6" in the previous step, group 47 will be displayed.

**Note** Group numbers over 50 are ignored.

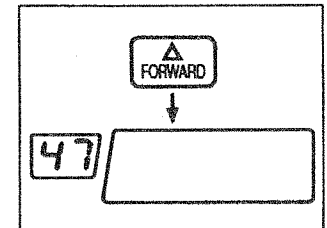





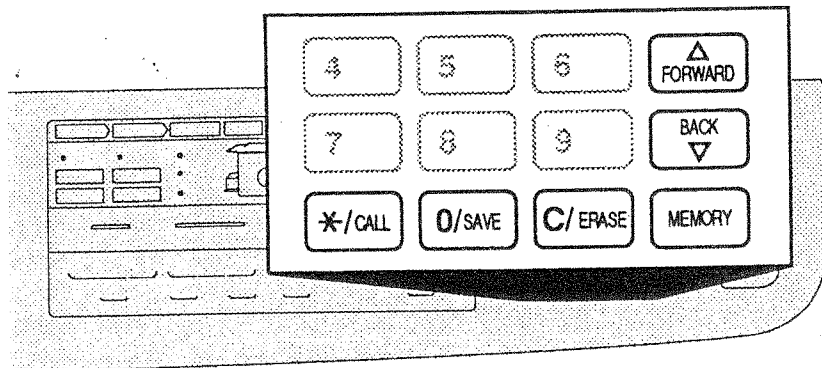

## Storing Settings in Memory

The Memory feature is a flexible tool for automating frequently used or complicated combinations of settings.

You can store up to 20 combinations of frequently used or complex print-job settings and apply them to new print jobs whenever necessary.

When you press the MEMORY button, the SAVE, CALL, and ERASE buttons can be used to save, recall, and delete combinations of settings in memory.

Any combination of the following settings and features can be saved in memory for quick recall:

- Program A or B printing settings
- Line or Photo processing
- Fine Enhance or Dot Photo processing
- Auto Print
- Two-Up printing
- Reproduction ratio
- Scanning Contrast
- Printing Position
- Printing Density or Print Speed
- Number of copies to be printed

When you are using the Memory feature, the Register Number appears in the Entry Number Display. As each Register Number is displayed, U ("used") or E ("empty") appears in the Print Quantity Display:



A combination of settings is already registered to the displayed Register Number.

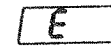

No combination of settings is currently registered to the displayed Register Number.

When you press the FORWARD button, Register Numbers are displayed in ascending order from 1. When you press the BACK button, Register Numbers are displayed in descending order.

## Saving Settings

Once settings are saved in memory, the combination remains registered until the ERASE button is used to remove it from memory.

**Note** It is recommended that you maintain a list of the Register Numbers currently in use and their associated settings.

### 1 Set up the desired settings.

Enter desired settings on the control panel.

### 2 Press the MEMORY button to activate the Memory feature.

The Entry Number Display shows *i*, and either E or U is shown on the Print Quantity Display.

If E appears on the print quantity display, skip step 3 and go to step 4.

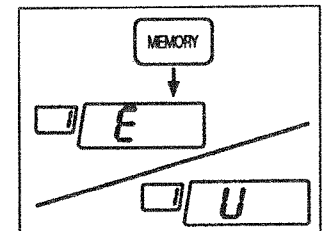



**3 Select an empty Register Number for the combination of settings entered.**

Press the FORWARD or BACK button to find an empty Register Number.

**Note** A Register Number with  $\bar{U}$  displayed cannot be overwritten. If you press the SAVE button, the  $\bar{U}$  flashes and short beeps sound for 2 seconds, indicating that registration is not allowed.

➔ **Page 38** — To save new settings to a Register Number that is currently in use, first erase the current settings and then save the new settings to the desired Register Number.

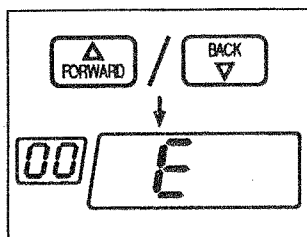

**4 Press the SAVE button to register the settings to the selected Register Number.**

A long beep sounds and  $\bar{U}$  is displayed in the Print Quantity Display for 1 second to indicate that the settings are registered.

**Note** The Memory feature is automatically canceled.

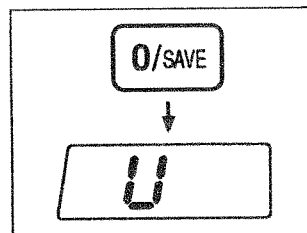

## Recalling Saved Settings

Use the CALL button to apply settings that are saved in memory.

**1 Press the MEMORY button to activate the Memory feature.**

The Entry Number Display shows  $\bar{U}$ .

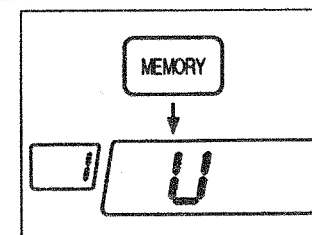

**2 Use the FORWARD or BACK buttons to select the Register Number with the settings you want.**

Be sure to select a Register Number with  $\bar{U}$  in the Print Quantity Display.

**Note** It is recommended that you maintain a list of the Register Numbers currently in use and their associated settings.

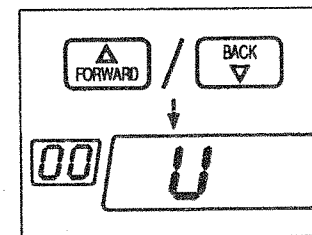

**3 Press the CALL button.**

The indicators and displays on the control panel light according to the settings recalled from memory, and a long beep sounds.

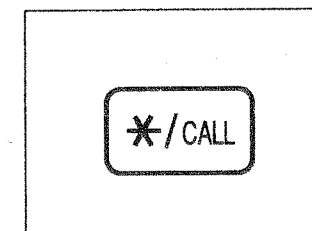

**Note** If you press the CALL button to recall a Register Number that is not in use,  $\bar{E}$  flashes and short beeps sound for 2 seconds.

The Memory feature is automatically canceled.



## Deleting Saved Settings

Use the ERASE button to clear all settings from a Register Number that is currently in use.

- 1 Press the MEMORY button to activate the Memory feature.**

The Entry Number Display shows  $\bar{U}$ .

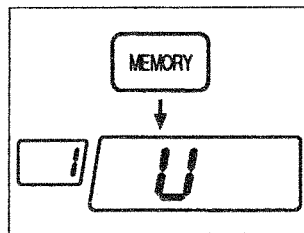

- 2 Use the FORWARD and BACK buttons to select the Register Number that you want to clear.**

Be sure to select a Register Number with  $\bar{U}$  in the Print Quantity Display.

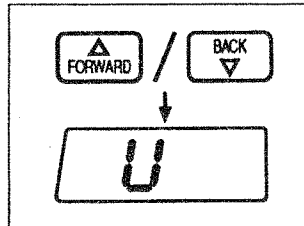

**Note** *It is recommended that you maintain a list of the Register Numbers currently in use and their associated settings.*

- 3 Press the ERASE button.**

The settings are erased and  $\bar{E}$  appears on the Print Quantity Display.

**Note** *If you press the ERASE button to clear a Register Number that is not in use,  $\bar{E}$  flashes and short beeps sound for 2 seconds.*

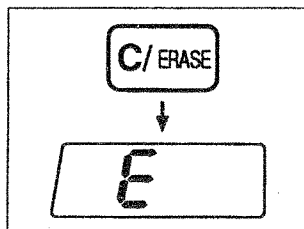

To exit the Memory feature, press the MEMORY button.



## Automatic Maintenance

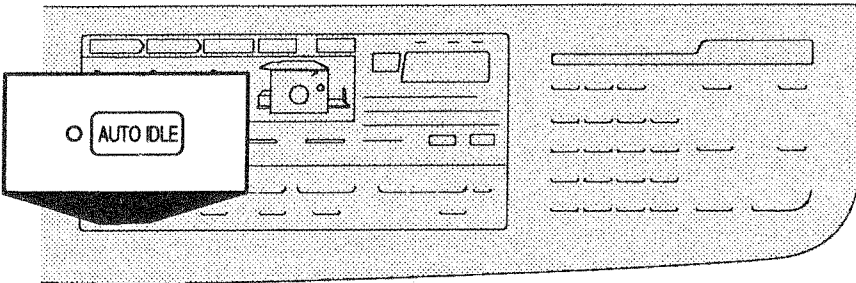

When the RISOgraph is not used for several hours, ink may dry on the Drum Unit. This can cause the first few sheets to be faint or blurred when printing starts again. The Automatic Idle feature assures consistent print quality.

Whenever the Automatic Idle indicator is lit, the Automatic Idle feature works. If you want this feature when the indicator is not lit, press the AUTOMATIC IDLE button to activate it.

The Automatic Idle feature is automatically activated if the power is switched ON when the RISOgraph unit is not used for a certain period (12 or 6 hours).

**Note** For ordinary or test printing after a long rest, the Automatic Idle feature is ignored even if the indicator is lit.

The minimum period required for automatic activation of the Automatic Idle feature may be selected.

➔ **Page 40** — You can customize initial settings.

## Return to Initial Settings

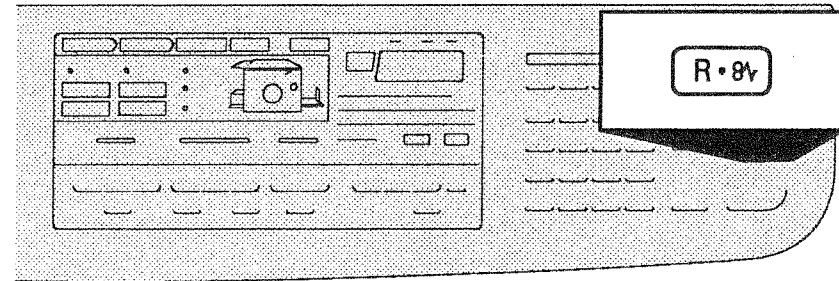

To return all the settings, including print position and reduction ratio, to initial status, turn the power OFF and ON again or hold down the ALL RESET button for more than 1 second.

**Note** If the initial settings have been customized, the customized settings will be returned by performing the procedure above.

INITIAL SETTINGS (at time of purchase)		
Original Mode Select	▶	<input checked="" type="radio"/> LINE <input type="radio"/> PHOTO
Size Adjustment	▶	<input checked="" type="radio"/> 100%
Print Quantity Display	▶	<input type="checkbox"/> <input type="checkbox"/> 0
Print Speed/Density	▶	SPEED <input checked="" type="radio"/> DENSITY <input type="radio"/> 1 2 3 4 5 ◀ <input type="checkbox"/> <input checked="" type="checkbox"/> <input type="checkbox"/> <input type="checkbox"/> ▶
Print Position	▶	-20 10 0 10 20+ <input type="checkbox"/> <input type="checkbox"/> <input checked="" type="checkbox"/> <input type="checkbox"/> <input type="checkbox"/> <input type="checkbox"/> <input type="checkbox"/> <input type="checkbox"/> <input type="checkbox"/> <input type="checkbox"/> <input type="checkbox"/>
Master-Making/Print	▶	<input type="radio"/> MASTER MAKING <input checked="" type="radio"/> PRINT
Original Scanning Contrast	▶	1 2 3 4 5 LIGHTER <input type="checkbox"/> <input type="checkbox"/> <input checked="" type="checkbox"/> <input type="checkbox"/> <input type="checkbox"/> DARKER





## Customizing the Initial Settings

You can change some of the initial settings to which the machine status will be returned when the power is turned ON or the **R • 8V** (ALL RESET) button is held down for more than 1 second.

The initial settings of the following settings can be changed (the settings at the time of purchase are shown in boldface):

Item Number	Initial Setting Item	Enter 0	Enter 1
01	Print Speed	<b>100 sheets/min</b>	60 sheets/min
02	Auto Print Feature	<b>OFF</b>	ON
04	Displayed Print Quantity	<b>0</b>	1
06	Auto Reset Time	<b>None</b>	5 minutes
08	Auto Idle Period	<b>12 hours</b>	6 hours

When you customize the initial settings, the settings remain valid until they are changed again.

### 1 Press 8 while holding down the CALL button.

Access the changeable initial settings.

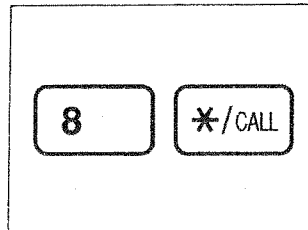

### 2 Check the Print Quantity Display.

Item number 01 and setting-status numbers 0 or 1 appear on the Print Quantity Display.

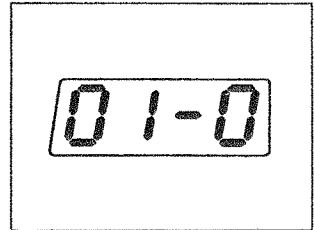

### 3 Enter an item number.

Enter the item number that you want to customize, using the Print Quantity keys.

For example, to select item number 02, enter 0 and 2.

**Note** If you want to change item number 01, just press the START button without entering an item number, then change the setting.

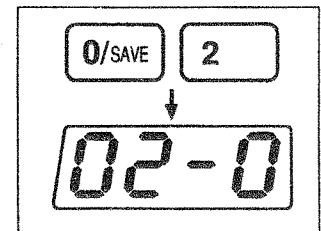

### 4 Press the START button.

Each time you press the START button, the setting-status number switches between 0 and 1. Select either number.

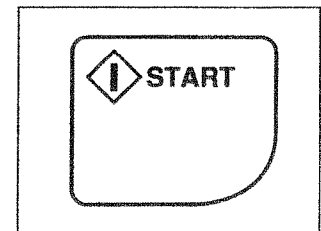

### 5 Press the R • 8V (ALL RESET) button.

After customizing the settings, hold down the ALL RESET button for more than 1 second.

The custom settings appear as the initial settings when the power is turned ON or the ALL RESET button is held down for more than 1 second.

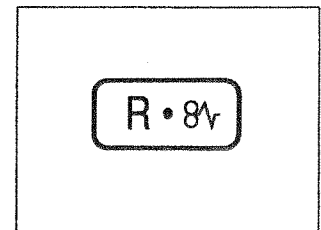



## Maintaining Your RISOgraph

---

### **WARNING – To Avoid Personal Injury During Handling**



- DO NOT allow unauthorized persons to make adjustments or repairs.
- DO NOT remove any fixed covers.
- CALL your Dealer immediately if you suspect any dangerous situations or have questions or problems with the machine.
- Precision parts and driving mechanisms are contained in the machine. Do not perform actions other than those described in this manual.
- Don't make any modifications to the machine or remove parts.
- When you want to move the machine, contact your RISO Dealer.

### **Caution – To Avoid Mechanical Problems**

- The best safety device is an alert person who demonstrates good sense.
- Neither RISO nor its dealer is responsible for maintenance service performed by non-RISO-authorized personnel.

## Replacing the Lithium Battery

The lithium battery in your RISOgraph should last about 5 years.

When the battery is losing power, the  (Call Service) Display will light and the code number  will appear.

### **Caution**

- The lithium battery must be replaced by a trained and authorized service technician.



## Cleaning Your RISOgraph

If the Thermal Print Head (in the Master Loading Unit) or the scanner (in the ADF Unit) is smudged with dust, dirt, ink, or correction fluid, printed copies may be stained or blurred.

Clean them periodically in the following way.

### Cleaning the Thermal Print Head

Clean the Thermal Print Head after you have replaced two Master Rolls.

Lift up the Original Feed Table and open the Master Loading Unit. Then gently wipe the Thermal Print Head (inside the Unit) several times with a soft cloth or tissue.

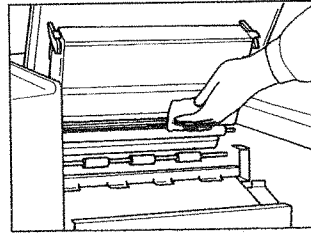

**Note** It is effective to dampen a soft cloth or tissue with a small amount of alcohol before wiping the Thermal Print Head.

**Caution**  
Since the Thermal Print Head is very delicate, avoid shocks or scratching with a hard object.

### Cleaning the Scanner

#### 1 Open the ADF Unit.

Open the ADF Unit while holding the ADF Unit Release Lever.

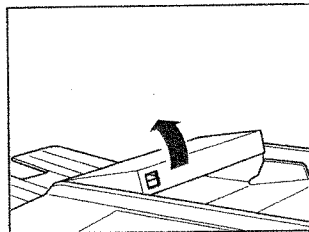

#### 2 Wipe the scanner glass.

Gently wipe the scanner glass several times with a soft cloth or tissue.

**Note** It is effective to dampen a soft cloth or tissue with a small amount of alcohol before wiping the scanner glass.

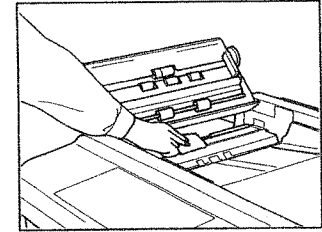

**Caution**  
Since the scanner glass is very delicate, avoid shocks or scratching with a hard object.

### Cleaning the Press Roller

If the rubber Press Roller that presses the printing paper against the Drum Unit is stained, smudged strips may appear on the back sides of prints.

Wipe the Press Roller gently with a soft cloth or tissue.

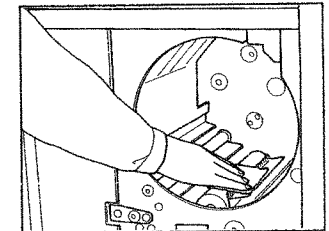

### Cleaning the Machine Exterior

To remove dust, wipe the machine exterior periodically with a soft cloth.

To remove stains, use an appropriate cleanser.

**Caution**  
The machine exterior is plastic. Never use alcohol or solvent for cleaning.

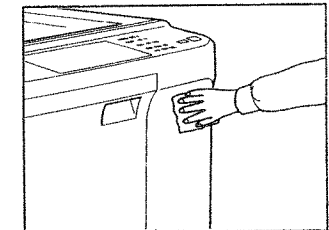



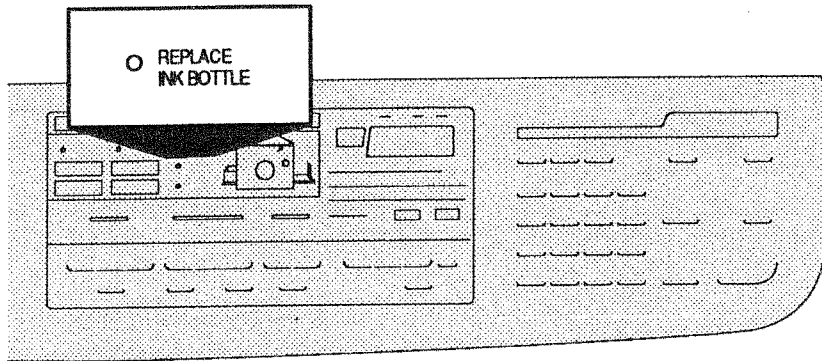

## Replacing the Ink Bottle

- 1** Open the Front Cover, and pull the empty ink bottle out of the machine.

Release the green Ink Bottle Locking Lever and pull the empty ink bottle out of the Drum Unit.

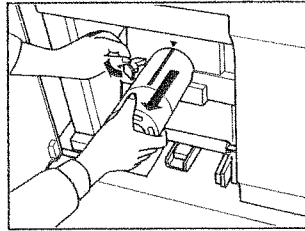

- 2** Remove the cap from the new ink bottle.

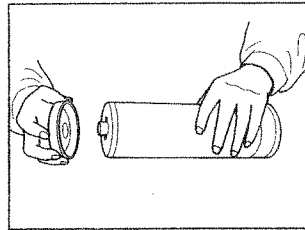

- 3** Align the arrow on the new ink bottle with the arrow marked on the drum.

While pushing the Ink Bottle Locking Lever aside, rotate the ink bottle until its arrow meets the arrow marked on the drum.

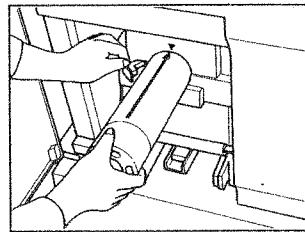

- 4** Insert the new ink bottle.

Insert the ink bottle all the way into the drum.

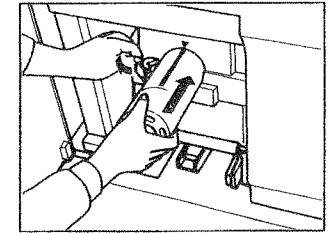

- 5** Lock the ink bottle into place, and close the Front Cover.

Return the Ink Bottle Locking Lever to its initial position to keep the ink bottle in place.

Press on the lower righthand area of the Front Cover to close it securely.

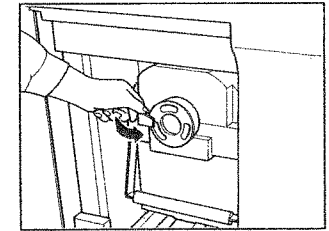

### **Important!**

- **Never insert a bottle of a different color ink.**

Always be sure that the color of the new ink bottle is the same as that of the old one. To change print color, replace the entire Drum Unit.

- **The master wrapped around the Drum Unit has ink on it. Keep your hands and clothing away from it.**

If your hands come into contact with ink, wash them immediately and thoroughly.





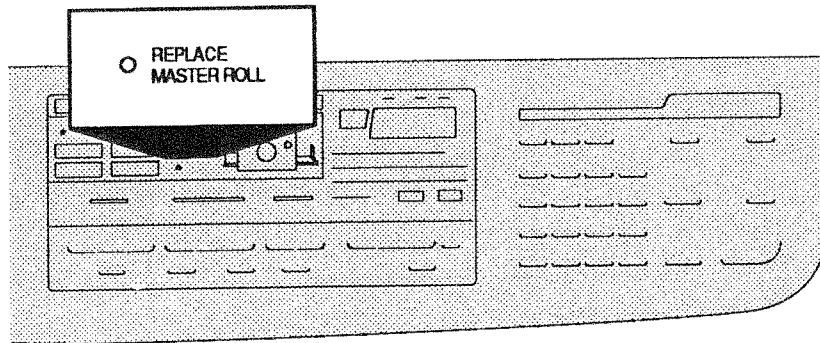

## Replacing the Master Roll

### 1 Raise the Original Feed Table.

Hold the Original Feed Table Release Lever and raise the Original Feed Table until it stops.

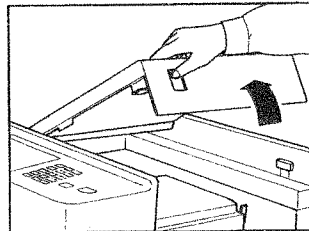

### 2 Open the Master Loading Unit.

Open the Master Loading Unit by pulling down the green Master Loading Unit Release Lever, which is located on the right side of the unit.

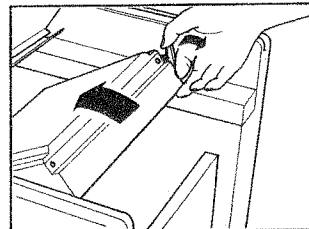

### 3 Open the Master Roll Cover.

Pull down the Master Roll Cover.

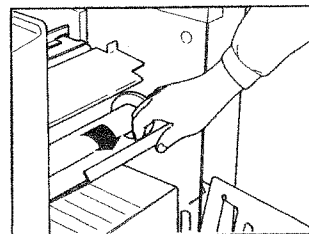

### 4 Remove the depleted Master Roll.

Pushing the depleted Master Roll to the right, pull it toward you and remove it from the supporter.

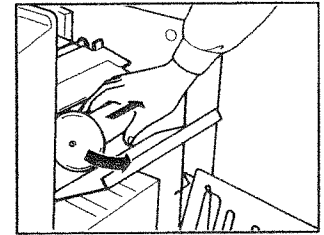

### 5 Remove both left and right flanges.

Remove both left and right flanges from the depleted Master Roll.

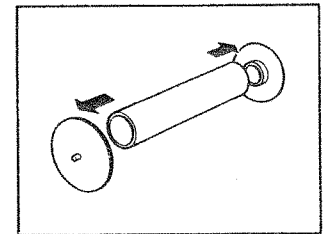

### 6 Attach the flanges to a new Master Roll.

Unpack a new Master Roll.

**Note** If you use the *RISOGRAPH RC Master*, remove both the left and right flanges from the new Master Roll.

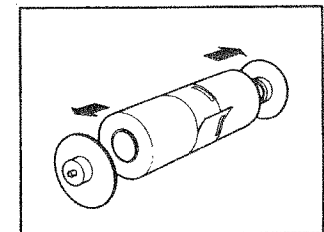

### **Important!**

**Do not use flanges removed from the new RISOGRAPH RC Master Roll.**

Attach the flanges removed from the depleted Master Roll to the new Master Roll, with the colored flange to the right end and the white flange to the left end.

Then unwrap the new Master Roll.

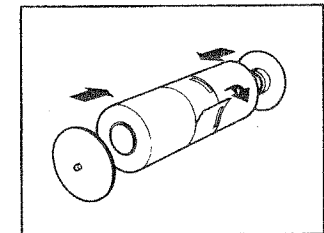



**7 Install the new Master Roll.**

Pushing the colored flange onto the righthand flange holder, slide the white flange securely into the center groove of the supporter.

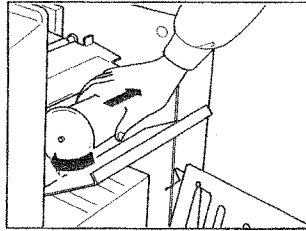

**8 Insert the leading edge of the master under the green film.**

Unroll the Master Roll by pulling on the leading edge and insert the leading edge under the green film.

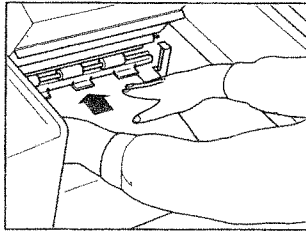

**9 Close the Master Roll Cover.**

Close the Master Roll Cover gently.

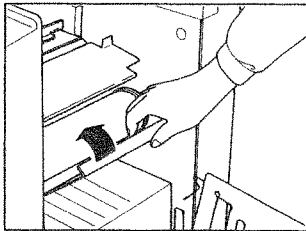

**10 Close the Master Loading Unit and the Original Feed Table.**

Close the Master Loading Unit gently and return the Original Feed Table to the original position.

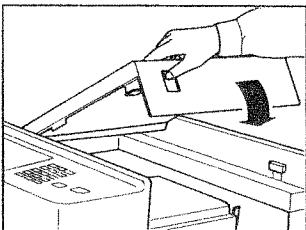
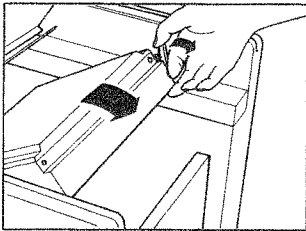

**Important!**

If the leading edge of the master is inserted too far beyond the green film, the excess portion will be automatically cut off. If the cut-off strip remains inside, the CHECK SETTINGS indicator flashes on the control panel. Be sure to remove the cut-off strip.

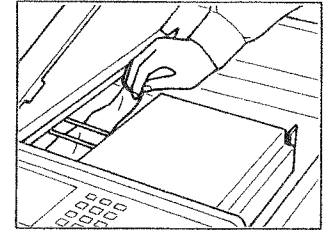



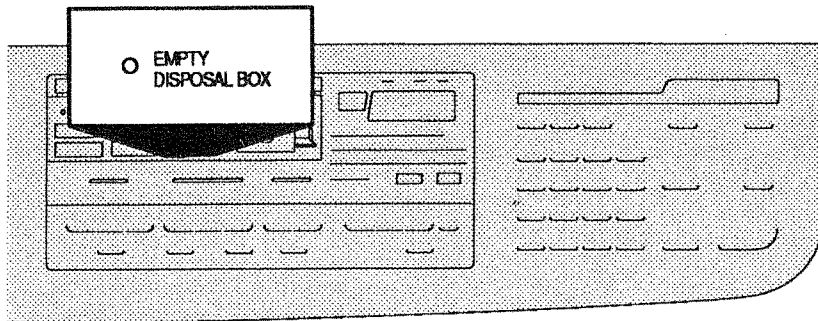

### 3 Insert the Master Disposal Box into position.

Holding the handles, insert the Master Disposal Box into position as far as it will go. Then release the handles.

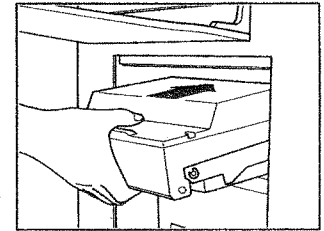

## Emptying the Master Disposal Box

### 1 Pull out the Master Disposal Box.

Hold together both the upper and lower handles of the Master Disposal Box and pull out the box.

**Note** When carrying the Master Disposal Box, be sure to hold the handles so as not to drop the used masters.

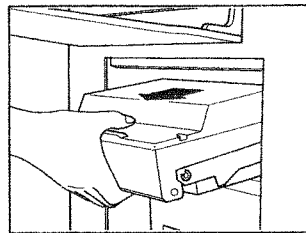

### 2 Discard used masters.

While holding the handles, open the cover by pulling up the locking lever and discard used masters.

Return the locking lever and close the cover.

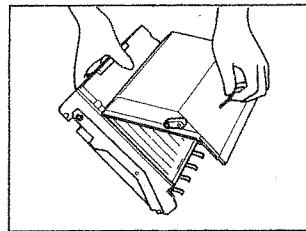



## Advisory Messages

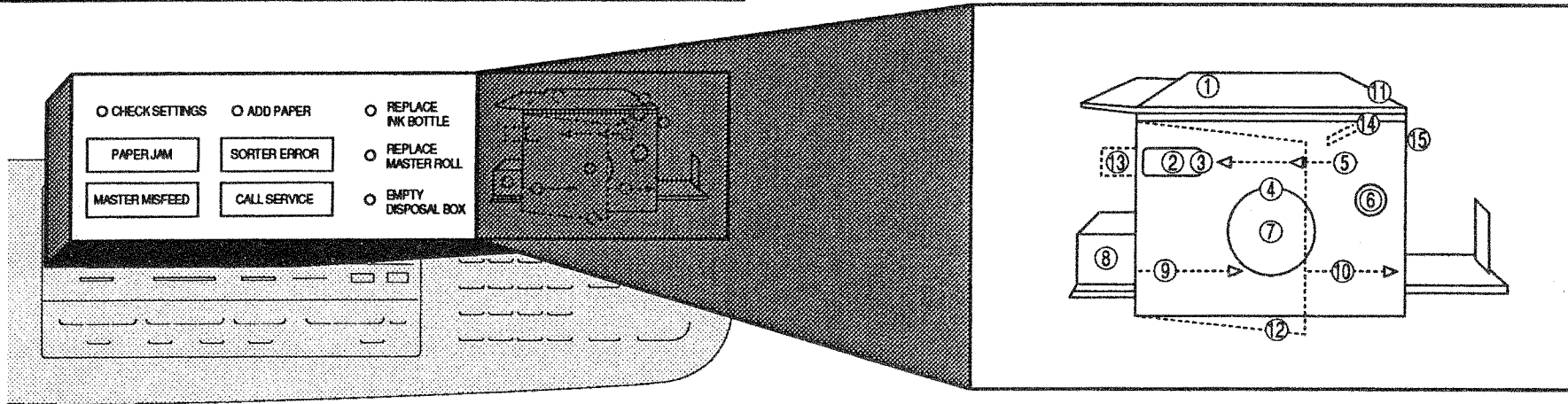

When the machine is not ready for use (when consumables are not installed, for example), an indicator lights or flashes on the display panel and a related code number appears on the Print Quantity Display.

The indicator shows machine status and the Machine Monitor Display indicates the problem location. The code number on the Print Quantity Display provides more detail about machine status.

If you need to contact technical support about a problem, inform the authorized service representative of the code number to help solve the problem quickly.





## CHECK SETTINGS

The CHECK SETTINGS indicator flashes when the Drum Unit, ink bottle, Master Roll, or Master Disposal Box are not properly installed, or a part of the machine (like the Front Cover) is not closed completely.

Location	Code Number	Description and Action
④ ⑪	E24	A strip of cut master remains in the machine. ➡ A cut-off piece of master is inside the Master Loading Unit. Open the Original Feed Table and Master Loading Unit, and remove the piece. ➡ Page 45
④ ⑫	E27	There is no master on the Drum Unit. ➡ Place an original on the Original Feed Table and start operation from master-making. ➡ Page 18
⑮	E51	No card is inserted into the Key/Card Counter. ➡ Insert a card into the Key/Card Counter and press the R • 8v (ALL RESET) button to clear the displays. ➡ Page 54
④ ⑫	E52	Drum Unit is not properly installed. ➡ Slide the Drum Unit all the way into place and then let down the lever. Be sure the Drum Unit is securely locked in place. ➡ Page 16
⑦ ⑫	E53	Ink bottle is not properly installed. ➡ Insert the ink bottle completely and then hook the locking lever onto it to securely lock it in place. ➡ Page 43 <b>Note</b> If the bottle is not completely inserted, it cannot be locked securely with the locking lever. Be sure to insert it firmly until it stops.
⑤ ⑪ ⑭	E54	Master is not properly loaded. ➡ Install the Master Roll in the Master Holder, if necessary. Be sure the leading edge of the master is inserted between the green plastic film tabs on the machine. ➡ Page 44
⑫	E55	Front Cover is not properly closed. ➡ Close the Front Cover tightly. ➡ Page 43
⑪	E56	Original Feed Table is not properly closed. ➡ Close the Original Feed Table tightly. ➡ Page 45
⑬	E57	Master Disposal Box is not properly installed. ➡ Holding the handles of the Master Disposal Box, insert the box completely. ➡ Page 46
⑭	E58	Master Loading Unit is open. ➡ Open the Original Feed Table and close the Master Loading Unit securely. Then return the Original Feed Table to its original position. ➡ Page 44
①	E59	ADF Unit is not properly closed. ➡ Close the ADF Unit tightly. ➡ Page 42
⑧	E60	There is an obstacle stuck on the Paper Feed Tray. ➡ Remove it. ➡ Page 14
④ ⑫	E61	Drum Unit is wrong type or size. ➡ Install a recommended Drum Unit. ➡ Page 16



## ADD PAPER

The ADD PAPER indicator flashes when paper is not loaded in the Paper Feed Tray.

---

Location	Code Number	Description and Action
⑧		Paper is not loaded in the Paper Feed Tray. ➡ Install paper in the Paper Feed Tray. ➡ <b>Page 14</b>

## REPLACE INK BOTTLE

The REPLACE INK BOTTLE indicator flashes when the ink bottle is empty.

---

Location	Code Number	Description and Action
⑦ ⑫		Ink Bottle is empty. ➡ Replace the empty ink bottle. ➡ <b>Page 43</b>

## REPLACE MASTER ROLL

The REPLACE MASTER ROLL indicator flashes when the Master Roll is depleted.

---

Location	Code Number	Description and Action
⑥ ⑪		Master Roll is depleted. ➡ Install a new Master Roll. ➡ <b>Page 44</b>

## EMPTY DISPOSAL BOX

The EMPTY DISPOSAL BOX indicator flashes when the Master Disposal Box is full of used masters.

---

Location	Code Number	Description and Action
②		Master Disposal Box is full. ➡ Pull out the Master Disposal Box and discard used masters. ➡ <b>Page 46</b>



## PAPER JAM

The PAPER JAM indicator flashes when printing paper or originals get jammed inside the machine or ADF Unit.

Location	Code Number	Description and Action	Location	Code Number	Description and Action
④ ⑨ ⑫	E31	Paper is jammed in the paper feed area. ➡ Open the Front Cover, pull out the Drum Unit, and remove the jammed paper from the paper feed area. ➡ <b>Page 16</b>	①	E38	An original is jammed inside the ADF Unit. ➡ Open the ADF Unit by holding the ADF Unit Release Lever. Remove the jammed original and reload it. ➡ <b>Page 42</b>
④ ⑩ ⑫	E32	Paper jammed in the paper ejection area. ➡ Open the Front Cover, pull out the Drum Unit, and remove the jammed paper from the paper ejection area. ➡ <b>Page 16</b>	①	E39	An original is jammed at the exit of the ADF Unit. ➡ Open the ADF Unit by holding down the ADF Unit Release Lever. Remove the jammed original and reload it. ➡ <b>Page 42</b>
⑨	E33	Printing paper was not fed, or was improperly fed. ➡ Check paper and Paper Feed Tray and press the R•R (ALL RESET) button. ➡ <b>Page 14</b>			
④ ⑫	E34	Printed paper is stuck to the drum. ➡ Open the Front Cover, pull out the Drum Unit, and remove the printing paper. ➡ <b>Page 16</b>			
①	E36	An original was not fed, or was improperly fed. ➡ Remove the original and reload it. ➡ <b>Page 18</b>			
①	E37	An original is jammed at the entrance to the ADF Unit. ➡ Open the ADF Unit by holding the ADF Unit Release Lever. Remove the jammed original and reload it. ➡ <b>Page 42</b>			

### Note To prevent paper/original jams:

- Print on paper free of folds. If using curled paper is unavoidable, place the printing paper so that the curl faces down. If you must use heavily curled paper as an original, use the carrier sheet.
- When using slippery paper for printing, set the Paper Feed Pressure Adjustment Lever to "CARD".  
 ➡ **Page 14**
- Printing paper tends to stick to the drum surface if the top margin is too narrow on the original, or if the upper portion of the original uses a large amount of ink. To solve this problem, lower the print position to provide a wider top margin or reverse the top and bottom of the original and then restart printing.  
 ➡ **Page 24**



## MASTER MISFEED

The MASTER MISFEED indicator flashes when an error occurs during master-making or master disposal.

Location	Code Number	Description and Action
⑤ ⑪ ⑭	E21	<p>Master is not loaded on the drum, or is improperly loaded on the drum.</p> <p>➡ <i>Open the Master Loading Unit and wind up the Master Roll. Reload the master. After closing the Master Loading Unit, press the START button to restart the master-making operation.</i></p> <p>➡ <b>Page 45</b></p>
⑤ ⑪ ⑭	E22	<p>Master was not fed properly.</p> <p>➡ <i>Open the Master Loading Unit, wind up the Master Roll, and reload the master.</i></p> <p>➡ <b>Page 45</b></p>
④ ⑫	E23	<p>Master was not cut correctly.</p> <p>➡ <i>Open the Front Cover and pull out the Drum Unit to see if the master is properly loaded on the drum. If not, restart the operation from master-making.</i></p> <p>➡ <b>Page 16</b></p>
③ ④ ⑫	E25	<p>A used master remains on the drum.</p> <p>➡ <i>Open the Front Cover, pull out the Drum Unit, and remove the remaining master from the drum. After returning the Drum Unit to its original position, press the START button.</i></p> <p>➡ <b>Page 16</b></p>

Location	Code Number	Description and Action
③	E26	<p>A used master is stuck at the entrance of the Master Disposal Box.</p> <p>➡ <i>Pull out the Master Disposal Box while holding the handles, and look inside. If the master remains, remove it.</i></p> <p>➡ <b>Page 46</b></p>





## SORTER ERROR

The SORTER ERROR indicator flashes if an optional sorter malfunctions. The trouble location is not indicated on the Machine Monitor Display. Check the error number below for detailed error information.

**Note** For details about using the optional sorter, please refer to the documentation provided with the sorter.

Location	Code Number	Description and Action
	£71	A paper jam has occurred. ➡ Open the sorter door, if necessary, and remove the jammed paper. Then close the door.
	£72	Sorter door or cover is open. ➡ Close the door or cover.
	£73	Paper remains in the sort bin. ➡ Open the sorter door and remove the paper. Then close the door.
	£74	No more paper can be accommodated. ➡ Open the sorter door, if necessary, and remove the sorted paper. Then close the door.
	£75	The specified size does not match the printing paper size. ➡ Remove printing paper of different size, or specify the correct size on the sorter.
	£76	Wrong paper size is specified. ➡ Specify the correct paper size on the sorter.
	£79	Job Separator Tape is depleted. ➡ Install a new Job Separator Tape.

## CALL SERVICE

If the CALL SERVICE indicator flashes, contact your authorized service representative and report the code number on the Print Quantity Display to authorized service personnel.



## Troubleshooting

If you have any of these problems, check the following items before calling your authorized service representative.

### ***The machine does not start even when you press the power switch.***

- Check to see that the power cord is firmly connected to an electrical outlet.
- Check to see that the power cord is connected to the machine.
- Check to see that the commercial power circuit breaker is normal.

### ***The $\text{E}$ and $\text{E55}$ advisory messages appear even when the Front Cover is closed.***

- There is a metal plate in the lower righthand section of the Front Cover. Unless this plate is in direct contact with the magnet on the lower righthand part of the machine, advisory messages remain on the control panel.
  - Press on the lower righthand area of the Front Cover to close it tightly.

### ***There is no image on prints.***

- Check to see if the original is correctly placed.
  - Be sure that the original is placed face-down.
    - **Page 18**
- Check to see if the master is correctly placed.
  - Be sure that the master is placed with the leading edge unrolled from above.
    - **Page 44**

### ***The background of an original is picked up on prints.***

- If newspaper or colored paper is used as an original, the background could be picked up on prints.
  - Press the SCANNING Contrast Adjustment button  $\triangleleft$  to make scanning contrast lighter. Then reset the original and press the START button.
    - **Page 21**
  - If the Fine Enhance indicator is lit, press the Image Processing selection button to cancel the Fine Enhance feature.
    - **Page 20**

### ***Printed images are excessively faint or blurred.***

- If the machine is not used for a long period of time, ink on the drum surface dries. Dry ink on the Drum Unit may cause faint or blurred printing.
  - Press the TEST PRINT button several times until a clear printed image is obtained.
    - **Page 21**
  - Turn ON the Automatic Idle feature before operation to prevent light images that may occur after periods of non-use.
    - **Page 39**
- Light originals result in light images.
  - Press the SCANNING Contrast Adjustment button  $\triangleright$  to make scanning contrast darker. Then reset the original and press the START button.
    - **Page 21**
- If the temperature is low (below 59° F, or 15° C) or the ink bottles are stored in a cold place, ink may not flow smoothly.
  - Warm the room or ink bottle before operating the machine.

### ***Printing paper slips when it is fed.***

- Misfeeding of printing paper could cause a paper jam.
  - Set the Paper Feed Pressure Adjustment Lever to 'CARD'.
    - **Page 14**

### ***Vertical blank lines are found on printed copies.***

- The Thermal Print Head (the device that makes the master) is smudged with paper powder from the master.
  - Open the Master Loading Unit and clean the Thermal Print Head using a soft cloth or tissue.
    - **Page 42**
- The scanner (the device that scans originals) glass is smudged with dust or correction fluid.
  - Open the ADF Unit and clean the glass using a soft cloth or tissue.
    - **Page 42**



**Printing paper sticks to the drum surface.**

- Use recommended printing paper.
- Lower the vertical print position with the PRINT POSITION Adjustment button ◀.  
➤ **Page 24**
- Replace the original in the reverse direction and restart printing from the beginning (master-making).

**The back of finished prints is smudged with ink.**

- The rubber Press Roller, which keeps printing paper pressed against the drum during printing, is stained with ink.  
➤ Remove the Drum Unit and clean the roller gently with a soft cloth or tissue.  
➤ **Page 42**
- The Feed Tray Paper Guides are set at maximum width.  
➤ Adjust the Feed Tray Paper Guides to fit the width of the printing paper.

**The Drum Unit does not go in all the way.**

- The Drum Unit does not go in all the way if the handle is let down.  
➤ Slide in the drum with the handle up, and lower the handle after the drum is fully inserted.  
➤ **Page 17**

## Optional Accessories

---

A variety of optional accessories are available to enhance the capabilities of the RISOgraph RA4900.

### Color Drum Units (RISOGRAPH RA Drum)

The six colors available are black, blue, red, green, brown, and yellow. Each Drum Unit has its own case for storage.

- **Page 16** — By exchanging Drum Units, you may achieve multicolor prints.

### RISOGRAPH Sorter TM2400

This compact sorter is capable of handling up to ledger (A3) paper. The sorter is equipped with an electric stapler so that you may efficiently create booklets from finished prints.

### Job Separator

This accessory efficiently sorts groups of prints with strips of paper as they are printed. The Job Separator is attached beside the Paper Receiving Tray.

### Key/Card Counter

This counter shows the number of printed sheets and the number of consumed masters produced within a preset period of time. This can help you control costs.



# Specifications

<b>Processing</b>	High-speed automatic digital scanning/fully automatic, thermal screening duplicating system
<b>Time to First Copy</b>	Approx. 17 seconds (letter, or A4 original)
<b>Print Speed</b>	5 selectable print speeds (60 to 130 sheets per minute)
<b>Scanning Resolution</b>	400 DPI
<b>Original Input Type</b>	Sheets
<b>Original Size</b>	4 x 6 inch (A6, or 100 x 148 mm) to 11 x 17 inch (ledger, A3, or 297 x 431 mm)
<b>Output Paper Size</b>	4 x 6 inch (postcard, or A6) to 11 x 17 inch (ledger, or A3)
<b>Paper Weight</b>	13-lb bond (46 g/m <sup>2</sup> ) to 110-lb index (210 g/m <sup>2</sup> )
<b>Image Area</b>	245 x 350 mm in B4 drum 7.8 inch x 13.7 inch in legal drum
<b>Paper Capacity</b>	1000 sheets in feed and receiving tray (16-lb bond or 64 g/m <sup>2</sup> )
<b>ADF Capacity</b>	50 originals
<b>Reduction Parameters</b>	4 selectable reductions: 94%, 77%, 75%, and 66% (94%, 87%, 82%, and 71% for metric models)
<b>Enlargement Parameters</b>	3 selectable enlargements: 141%, 127%, and 121% (144%, 122%, and 116% for metric models)
<b>Zooming Parameters</b>	50% to 200%
<b>Features</b>	Print Speed/Density control, confidential mode, Two-Up printing, programmed printing, memory storage of frequently used settings, Fine Enhance, Dot-screening, interface capabilities, photo enhancement, Automatic Idle, ADF, and scanning contrast adjustment
<b>Print Colors</b>	Six colors available as optional accessories (black, blue, red, green, brown, yellow)

## Optional Accessories

Color Drum Units, Sorter TM2400, Job Separator, Key/Card Counter

## Power Source <Requirements>

- USA Model:* • 120 VAC, 60 Hz <3.5A>  
*Metric Models:* • 110 VAC, 60 Hz <3.5A> (110-V model)  
 • 220 to 240 VAC, 50/60 Hz <3.0A> (220-V model)

**⚠ WARNING** Always check the rating plate on the machine before connecting the power

## Weight

Approx. 192 lbs. (87 kg)

## Dimensions (W x D x H)

53.5 x 24.8 x 23.2 inch in use (1360 x 631 x 589 mm)  
 25.6 x 24.8 x 23.9 inch in storage (650 x 631 x 606 mm)











**Please contact following for supplies and service:**

