

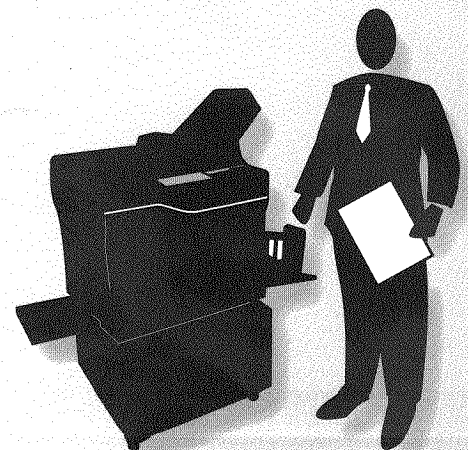

# RISOGRAPH GR3770

USER'S GUIDE





**If the optional ADF Unit is installed...**

Please remove pages 7-10, 15-16, 21-26, 39-40 and 79-80 and replace them with the corresponding pages located at the back of this User's Guide.

**RISO MAKES NO WARRANTY OF ANY KIND WITH REGARD TO THIS USER'S GUIDE, INCLUDING, BUT NOT LIMITED TO, THE IMPLIED WARRANTIES OF MERCHANTABILITY AND FITNESS FOR A PARTICULAR PURPOSE. RISO SHALL NOT BE LIABLE FOR ERRORS CONTAINED HEREIN OR FOR INCIDENTAL OR CONSEQUENTIAL DAMAGES IN CONNECTION WITH THE FURNISHING, PERFORMANCE OR USE OF THIS USER'S GUIDE. RISO ASSUMES NO LIABILITY FOR DAMAGES RESULTING FROM THE USE OF THE INFORMATION CONTAINED HEREIN.**

**FCC Warning**

This equipment has been tested and found to comply with the limits for a Class A digital device, pursuant to Part 15 of the FCC Rules. These limits are designed to provide reasonable protection against harmful interference when the equipment is operated in a commercial environment. This equipment generates, uses, and can radiate radio frequency energy and, if not installed and used in accordance with the instruction manual, may cause harmful interference to radio communications. Operation of this equipment in a residential area is likely to cause harmful interference, in which case the user will be required to correct the interference at his own expense.

**DOC Warning**

This digital apparatus does not exceed the Class A limit for radio noise emissions from digital apparatus as set out in the Radio Interference Regulation of the Canadian Department of Communications.

Le présent appareil numérique n'émet pas de bruits radioélectriques dépassant les limites applicables aux appareils numériques de la Classe A prescrites dans le Règlement sur le brouillage radioélectrique édicté par le Ministère des Communications du Canada.

# CONTENTS

Welcome to the Risograph GR3770.....	4
<b>Introduction to Your Risograph</b> .....	<b>5</b>
Cautions Concerning Installation .....	6
Location and Environment .....	6
Power Connections .....	6
Overview of Features .....	7
Knowing the Parts and Components .....	8
Upper Area .....	8
Paper Feed Area .....	8
Master-Making Area .....	9
Front Area .....	9
Paper Receiving Area .....	9
The Control Panel.....	10
Main Control Panel.....	10
Display.....	11
Sub Control Panel.....	11
The Main Display .....	12
<b>Getting Ready to Use Your Risograph</b> .....	<b>13</b>
Paper Recommendations.....	14
Size and Weight Restrictions .....	14
Guides for Trouble-Free Use .....	14
Storing Environment.....	14
Originals and Processing .....	15
Size and Weight Restrictions .....	15
Guides for Selecting Processing .....	15
Preparing to Print .....	16
Setting Up the Paper Feed Tray .....	16
Adding or Replacing Paper .....	16
Setting Up the Paper Receiving Tray.....	17
Closing the Paper Receiving Tray .....	18
<b>Basic Features</b> .....	<b>19</b>
Cautions Concerning Handling and Operation .....	20
Basic Processes .....	21
Basic Operation .....	22
Photo/Half-Tone Processing.....	24
Producing Proof Copies .....	25
Automatic Printing.....	26
<b>Adjustment Features</b> .....	<b>27</b>
Reducing and Enlarging Originals.....	28
Using Preset Reduction and Enlargement.....	28
Using Zoom .....	29
Changing Image Contrast on Prints .....	30
Producing Enhanced Prints .....	31
Producing Enhanced Photo Images.....	31
Producing Dotted Images.....	31
Reproducing Bound Documents .....	32
Repositioning the Print.....	33
Adjusting Vertical Print Position .....	33
Adjusting Horizontal Print Position .....	33



Changing Print Speed .....	34
Changing Print Density .....	35
Return to Initial Settings .....	36

**Special Features 37**

Printing Originals Side by Side .....	38
Printing the Same Original Two-Up .....	38
Printing Two Different Originals Two-Up .....	39
Automatic Sorting into Groups .....	41
Setting Up Program A .....	42
Setting Up Program B .....	44
Storing Settings in Memory .....	46
Saving Settings .....	47
Recalling Saved Settings .....	48
Deleting Saved Settings .....	49
Protecting Confidential Documents .....	50
Automatic Idle .....	51
Customizing the Initial Settings .....	52
Changing Print Color .....	54
Changing Print Cylinders (Drums) .....	54
Interfacing with a Computer .....	56

**Replenishing and Disposing Supplies 57**

Replacing the Ink Cartridge .....	58
Replacing the Master Roll .....	60
Emptying the Master Disposal Box .....	62

**Advisory Messages 63**

Index .....	63
-------------	----

**Troubleshooting Tips 69**

Tips List .....	69
-----------------	----

**Maintenance 73**

Cautions Concerning Maintenance .....	74
Replacing the Lithium Battery .....	74
Cleaning: Preventing Defective Prints .....	75
Cleaning the Thermal Print Head .....	75
Cleaning the Stage Glass and Stage Cover .....	75
Cleaning the Pressure Roller .....	75
Cleaning the Risograph Exterior .....	76
Cleaning the Optional ADF Scanner Glass .....	76
Cleaning the White Roller .....	76

**Appendices 77**

Optional Accessories .....	78
Specifications .....	79

**Index 80**

**Optional ADF Unit Replacement Pages**

**BUSINESS REPLY MAIL**

**Register Sheet for Memory Feature**

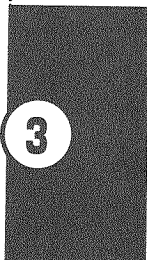

# Welcome to the Risograph GR3770

With its easy-to-read LCD display and key entry for most procedures, this equipment has been specially designed for simple operation.

## About This User's Guide

This Guide provides all information necessary to use your Risograph GR3770. It is designed to help you take advantage of the features built into the Risograph GR3770, and provides information on maintenance and troubleshooting.

### [Pictorial Guide]



### Pictorial Description

Describes a feature available in GR3770 with a picture.

### Panel Highlight

Indicates the key and/or indicator to be used or referred to during operation.

### Main Display Frame

Indicates the message to be displayed in relation to an instructed operation.

### Operation Instruction

Describes operation procedures with simple numbered steps.

### Cross-reference Remark

Indicates other sections of the User's Guide where you can find related descriptions.

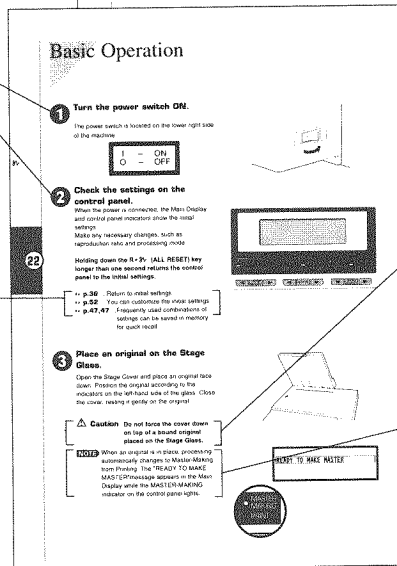
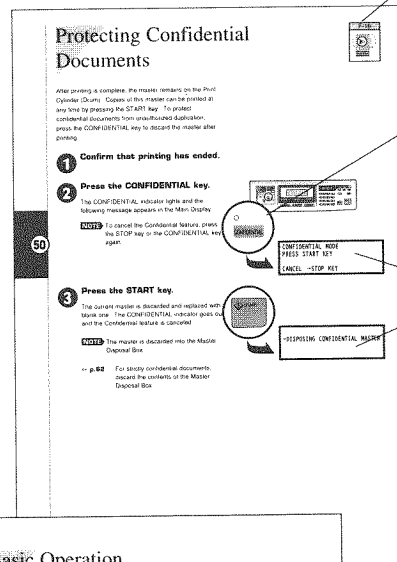

### Safety Remark

Gives you safety instructions under the following icons:



### Advice Remark

Gives you helpful advice for trouble-free operation under the following heads:



If you have installed the optional ADF Unit on your machine, use the special Replacement Pages which are provided at the back of this User's Guide.

# Introduction to Your Risograph

This section provides the basic information about your Risograph, including initial installation, an overview of features, and names of parts.

- **Cautions Concerning Installation** .....6
  - Location and Environment.....6
  - Power Connections .....6
- **Overview of Features** .....7
- **Knowing the Parts and Components**.....8
- **The Control Panel** .....10
- **The Main Display** .....12

# Cautions Concerning Installation

Follow the directions below for proper location and environment when installing your Risograph. They are intended to increase safety and prolong the life of your equipment.

## Location and Environment

Your dealer will help determine a proper location for your unit at the time of delivery.

- ⚠ Caution**
- Install the unit near the electrical outlet to avoid using an extension cord between the unit and the electrical outlet. If an extension cord is unavoidable, do not use one longer than 15 ft (5 m).
  - Do not allow anything to rest on or roll over the power cord, and do not place the unit where the power cord is subject to traffic or abuse. This can result in a shock or fire hazard.
  - Maintain adequate distance from the rear wall to allow easy connection/disconnection of the power cord.

6

### Important! [ To Avoid Mechanical Problems ]

- Avoid dusty locations, such as near blackboards.
- Select a location where the unit will be level (maximum of  $\pm 3/8$  inch ( $\pm 10$  mm) differential allowed).
- Avoid locations where direct sunlight will fall on the unit. If this is unavoidable, protect the unit with a curtain or shade on windows.
- Install within the recommended temperature range: 59°F to 86°F (15°C to 30°C) with moderate humidity (40% to 70%, no condensation).
- Avoid situations of sudden temperature change.
- Avoid locations where heat or air is directed onto the unit from an air conditioner or a heater.

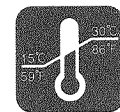

## Power Connections

### ⚠ WARNING [ To Avoid Personal Injury ]

- Securely insert the power cord plug into the electrical outlet to ensure proper electrical connection.
- Do not overload the electrical outlet or extension cord, as it can result in fire or electrical shock (check the "Specifications" section for the allowable range).
- Make sure that the power cord plug is not crushed under other pieces of machinery or stepped on by normal traffic.

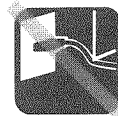

# Overview of Features

Your Risograph is a high-quality digital printer that is as easy to use as a copier.

- **Easy to Use and Fully Automatic**

The control panel shows you the features available and the current status of your Risograph with indicator lights, easy-to-read LCD displays, and includes a convenient "Machine Monitor" for troubleshooting.

Your Risograph processes your original by first making a master and then printing. The LCD display always shows the current process.

- **Print Speed and Density Control**

Any of five print speeds and densities can be selected for optimum performance.

- **Confidential Feature**

An original can be printed and the master can be automatically discarded to prevent further, unauthorized printing.

- **Image and Text Processing Options**

In addition to the standard processes for sharp line definition and accurate shading patterns, special photo contrast enhancement and 3-pattern dot-screen processes are available. The binding of a bound document can also be erased or lightened.

- **Color Printing Options**

Optional ink colors are available, by simply changing the Print Cylinder (Drum).

- **Zoom Enlargement and Reduction Capabilities**

Prints can be reduced or enlarged from 50% to 200% in 1% increments, according to your needs. Pre-set standard reduction and enlargement are also available (e. g., legal→letter or A3→A4).

- **Programmable Print Groupings**

Simple control panel entries can automate different types of groupings to save time finishing your print jobs.

- **Programmable Print Jobs**

Frequently used or complex print job settings can be stored in memory for instant recall.

- **Two-Up Printing**

Originals can be printed side by side on a single sheet.

- **Automatic Idle**

This feature ensures an excellent first copy when printing starts again after a period of idle time.

# Knowing the Parts and Components

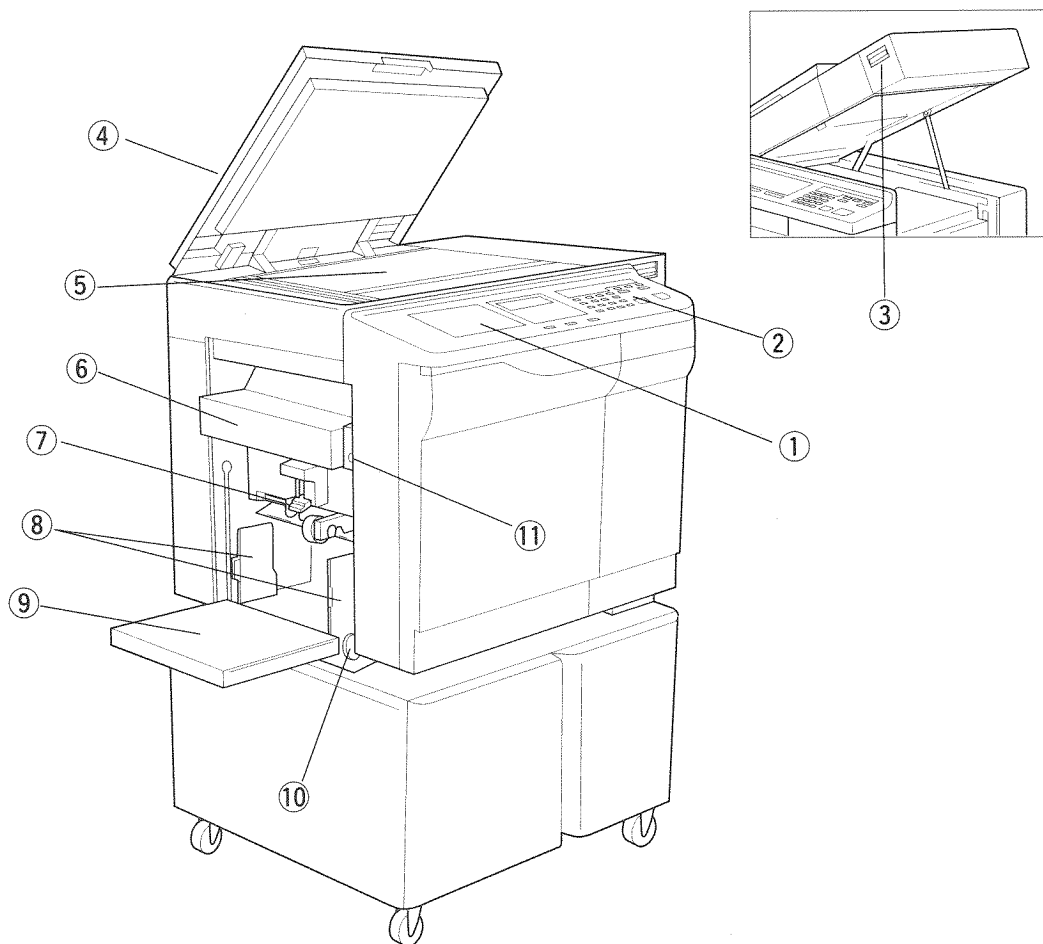

## Upper Area

- ① **Sub Control Panel** (see p.11)
- ② **Main Control Panel** (see p.10)
- ③ **Scanner Table Release Lever**  
Unlocks and opens the Scanner Table.
- ④ **Stage Cover** (see p.75)  
Secures the original placed on the Stage Glass.
- ⑤ **Stage Glass** (see p.75)

## Paper Feed Area

- ⑥ **Master Disposal Box** (see p.62)  
Holds discarded masters.
- ⑦ **Paper Feed Pressure Adjustment Lever**  
(see p.16)  
Adjusts the paper feed pressure according to the paper being used.
- ⑧ **Feed Tray Paper Guides** (see p.16)  
Holds and guides paper.
- ⑨ **Paper Feed Tray** (see p.16)
- ⑩ **Left/Right Print Position Adjustment Dial**  
(see p.33)  
Moves the print position to the left or right.
- ⑪ **Feed Tray Down Button** (see p.16)  
Lowers the Paper Feed Tray for replacing or adding printing paper.

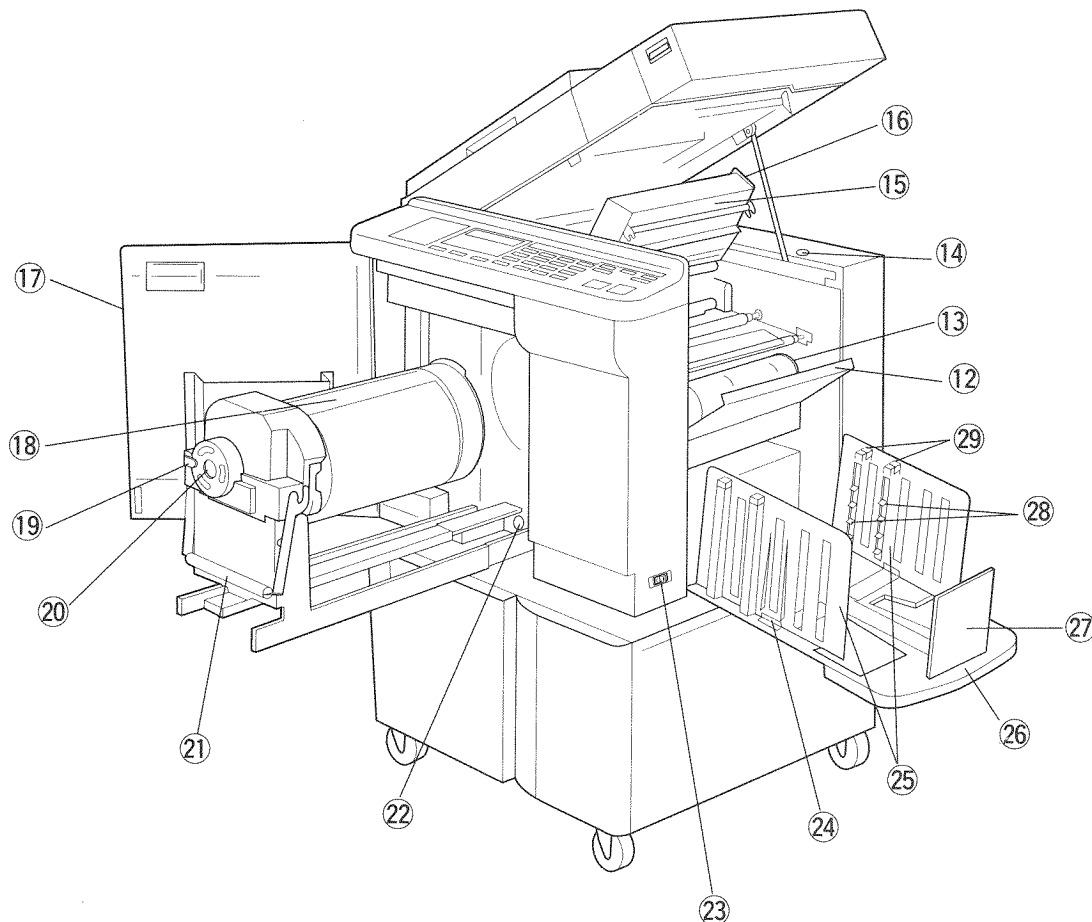

### Master-Making Area

- ⑫ **Master Roll Cover** (↪ p.60)  
Protects the Master Roll.
- ⑬ **Master Roll** (↪ p.60)
- ⑭ **Master Loading Button** (↪ p.60)  
Loads as well as cuts the master.
- ⑮ **Master Loading Unit** (↪ p.60)  
Makes a master from the scanned original.
- ⑯ **Master Loading Unit Release Lever**  
(↪ p.60)  
Opens the Master Loading Unit.

### Front Area

- ⑰ **Front Cover**
- ⑱ **Print Cylinder (Drum)** (↪ p.54)  
Holds the master.
- ⑲ **Ink Cartridge Locking Lever** (↪ p.58)  
Secures the Ink Cartridge in position.
- ⑳ **Ink Cartridge** (↪ p.58)
- ㉑ **Print Cylinder (Drum) Handle** (↪ p.54)  
Used to slide the Print Cylinder (Drum) forward.

- ㉒ **Print Cylinder (Drum) Home Position Button/Indicator** (↪ p.54)  
Positions and unlocks the Print Cylinder (Drum) for removal.
- ㉓ **Main Power Switch** (↪ p.22)

### Paper Receiving Area

- ㉔ **Receiving Tray Paper Guide Adjustment Knob** (↪ p.17)
- ㉕ **Receiving Tray Paper Guides** (↪ p.17)  
Aligns printed paper neatly.
- ㉖ **Curved Paper Receiving Tray** (↪ p.17)
- ㉗ **Paper Stop** (↪ p.18)  
Stops printed paper ejected into the Paper Receiving Tray.
- ㉘ **Paper Arranger** (↪ p.17)  
Helps arrange printed paper ejected into the Paper Receiving Tray.
- ㉙ **Paper Arranger Adjustment Knob** (↪ p.17)

# The Control Panel

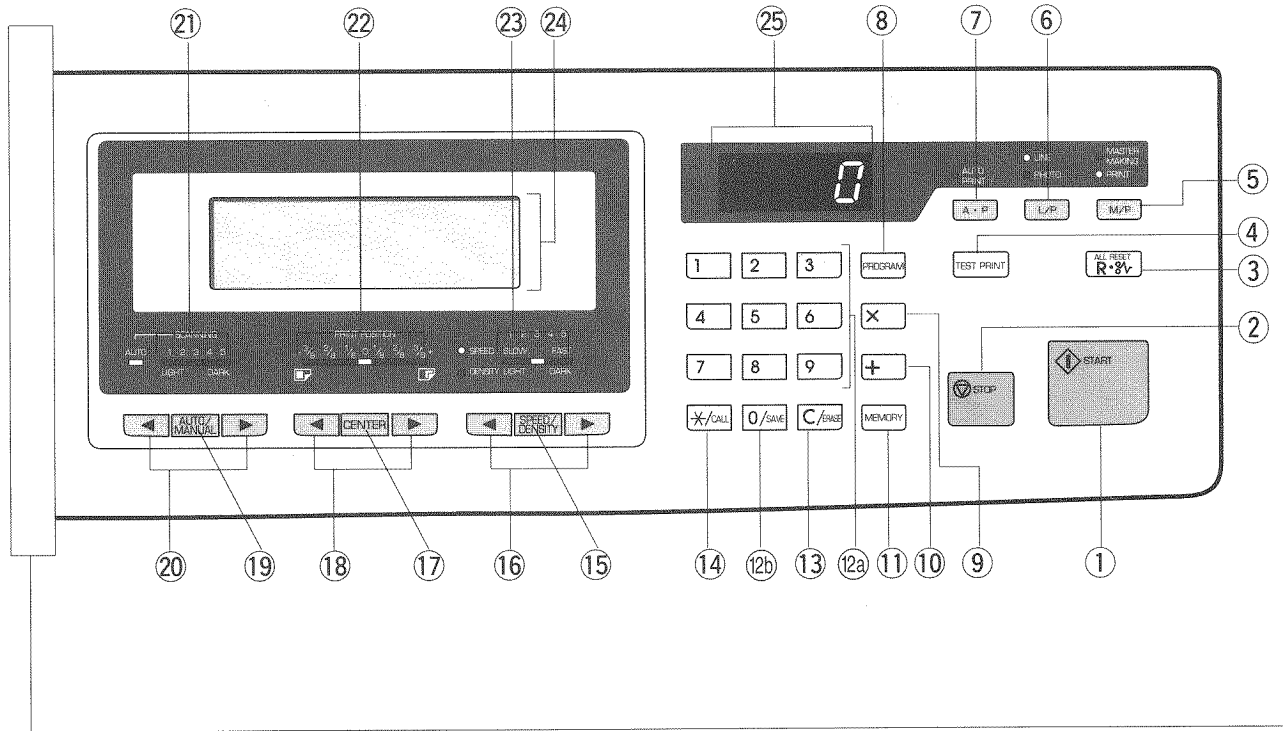

10

## Main Control Panel

- ① **START Key**  
Starts printing or master-making process. The indicator is "GREEN" when the key is active. This key is also used to resume operation after troubleshooting.
- ② **STOP Key**  
Interrupts printing, and cancels confidential feature.
- ③ **R • %v (ALL RESET) Key (p.36)**  
Returns all settings to initial status. This key is also used to clear error messages after troubleshooting.
- ④ **TEST PRINT Key (p.25)**  
Prints a sample from the current master to allow you to check print quality and printing position.
- ⑤ **MASTER-MAKING/PRINT (M/P) Key**  
Switches between Master-Making and Printing operations. Normally, selection is made automatically according to the current process.
- ⑥ **LINE/PHOTO Key (p.24)**  
Switches the current processing mode among Line, Photo and Duo. The indicators light according to the selected mode.
- ⑦ **AUTO PRINT Key (p.26)**  
Automates the process of master-making through printing. The indicator lights when the feature is active.
- ⑧ **PROGRAM Key (pp.41-45)**  
Provides access to programmed grouping of prints.
- ⑨ **x Key (pp.41-45)**  
Use when making program settings.
- ⑩ **+ Key (pp.41-45)**  
Use when making program settings.
- ⑪ **MEMORY Key (pp.46-49)**  
Provides access to the Memory features.
- ⑫a **Print Quantity Keys (0 to 9 Keys)**  
Use these keys to enter the number of copies to be printed, or to enter other numeric values.
- ⑫b **0/SAVE Key (p.47)**  
Use to store settings in memory.
- ⑬ **C/ERASE Key (p.49)**  
Cancels the number entered and resets the Print Quantity Display to zero. Also erases contents of memory.
- ⑭ **\*/CALL Key (p.48)**  
Use for memory recall.
- ⑮ **PRINT SPEED/DENSITY Selection Key (p.34,35)**  
Switches between print speed and printing density modes. The indicators light when the mode is active.
- ⑯ **PRINT SPEED/DENSITY Adjustment Keys (◀ ▶) (p.34,35)**  
Adjusts print speed or density (on a 1 to 5 scale).



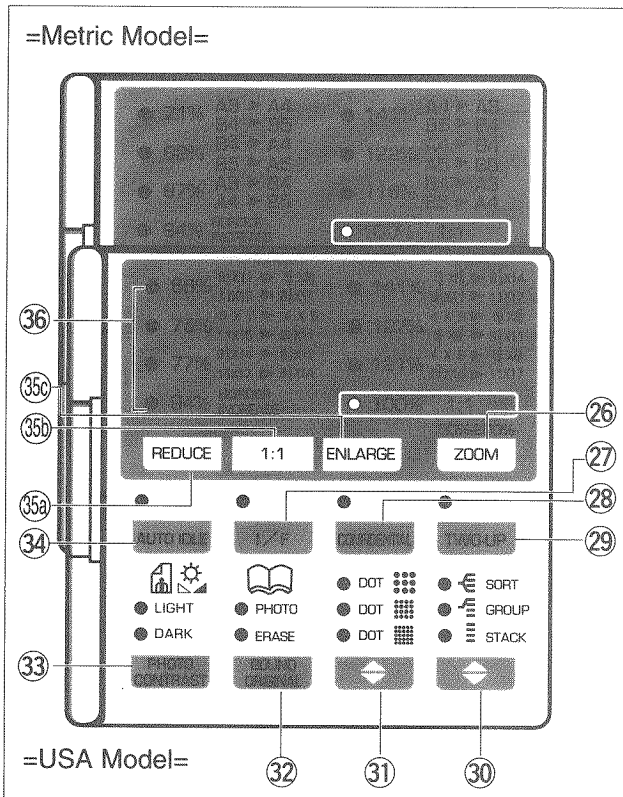

- ①⑦ **PRINT POSITION CENTER Key**  
(<sup>☞</sup> p.33)  
Moves vertical print position back to center.
- ①⑧ **PRINT POSITION Adjustment Keys**  
(◀ ▶) (<sup>☞</sup> p.33)  
Adjusts vertical print position.
- ①⑨ **SCANNING CONTRAST Mode Key**  
(<sup>☞</sup> p.30)  
Switches between auto and manual scanning contrast adjustment modes. The indicator lights when the auto-adjustment mode is selected.
- ②① **SCANNING CONTRAST Adjustment Keys** (◀ ▶) (<sup>☞</sup> p.30)  
Selects contrast adjustments (on a 1 to 5 scale) for the darkness of the original to be scanned.

### Display

- ②① **ORIGINAL SCANNING CONTRAST Indicator** (<sup>☞</sup> p.30)  
Shows the current original scanning contrast in the manual scanning contrast adjustment mode.
- ②② **PRINT POSITION Indicator** (<sup>☞</sup> p.33)  
Shows the current vertical print position.
- ②③ **PRINT SPEED/DENSITY Indicator**  
(<sup>☞</sup> p.34, 35)  
Shows the selected print speed or density.
- ②④ **Main Display** (<sup>☞</sup> p.12)  
Describes the current equipment status or gives instructions for operation.

- ②⑤ **Print Quantity Display**  
Counts the number of printed copies.

### Sub Control Panel

- ②⑥ **PRESET SIZE/ZOOM Selection Key**  
(<sup>☞</sup> p.28,29)  
Switches between the preset reduction/enlargement and zoom.
- ②⑦ **INTERFACE (I/F) Key** (<sup>☞</sup> p.56)  
Allows data transmission between the Risograph and external equipment, such as personal computers, with the optional computer interface.  
The indicator lights when an interface line is opened.
- ②⑧ **CONFIDENTIAL Key** (<sup>☞</sup> p.50)  
Protects confidential documents from unauthorized duplication. The indicator lights when the feature is active.
- ②⑨ **TWO-UP Key** (<sup>☞</sup> p.38, 39)  
Reproduces two prints side by side on one sheet of paper. The indicator lights when the feature is active.
- ③① **DOT PHOTO Selection Key** (<sup>☞</sup> p.31)  
Selects among 3 kinds of Dot Photo processing features. The Dot Photo feature processes a photo original with dot screen. The indicators light when the feature is active.

- ③② **BOUND ORIGINAL Selection Key**  
(<sup>☞</sup> p.32)  
Erases or brightens the binding shadow (gutter) of an open, bound original placed on the Stage Glass. The indicators light when the feature is active.
- ③③ **PHOTO CONTRAST Enhancement Key**  
(<sup>☞</sup> p.31)  
Increases or decreases shades of photo originals. The indicators light when the feature is active.
- ③④ **AUTO IDLE Key** (<sup>☞</sup> p.51)  
When switched ON, the Print Cylinder (Drum) is automatically rotated on a preset basis to ensure excellent first print quality. The indicator lights when AUTO IDLE is switched ON.
- ③⑤a **REDUCE Key** (<sup>☞</sup> p.28, 29)  
Selects any of four preset reduction sizes or decreases the zoom percentage.
- ③⑤b **1:1 Key** (<sup>☞</sup> p.28, 29)  
Returns the reproduction size to 1:1 (100%).
- ③⑤c **ENLARGE Key** (<sup>☞</sup> p.28, 29)  
Selects one of three preset enlargement sizes or increases the zoom percentage.
- ③⑥ **Preset Reduction/Enlargement Size Indicator** (<sup>☞</sup> p.28, 29)  
Shows the current preset reduction or enlargement size.

# The Main Display

## - Program Feature Display -

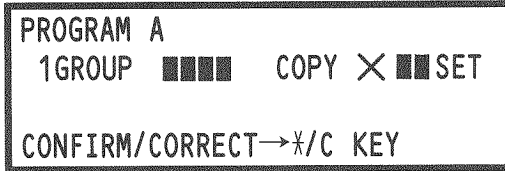

## - Memory Feature Display -

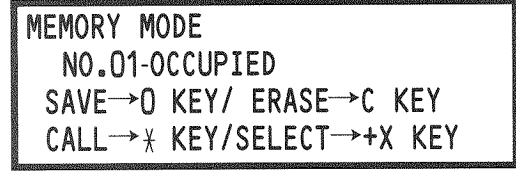

## - Basic Display -

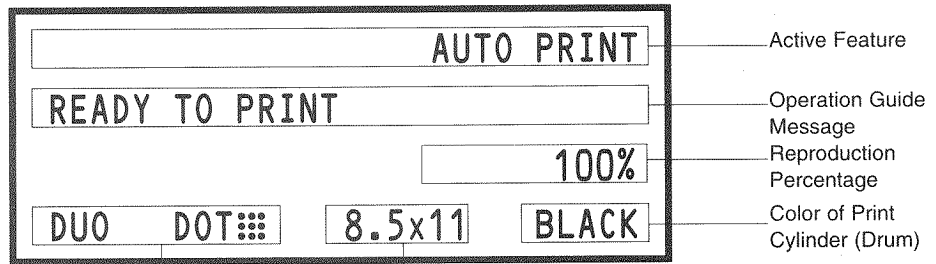

Active Image Processing

Printing Paper Size

(pp.52,53)

(pp.63-68)

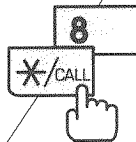

? When the equipment needs HELP;

## - Initial Setting Selection Display -

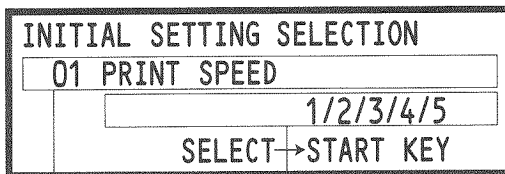

Setting-Changeable Item

Selectable Setting

## - Advice Display -

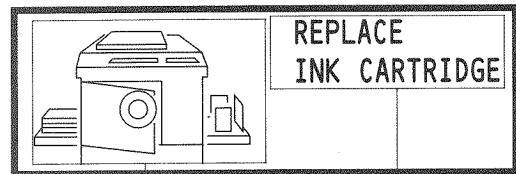

Machine Status Monitor

Instruction Message

# Getting Ready to Use Your Risograph

This section describes how to set your Risograph for initial use, with basic information on printing paper and originals.

- **Paper Recommendations** .....14
  - Size and Weight Restrictions .....14
  - Guides for Trouble-Free Use.....14
  - Storing Environment .....14
- **Originals and Processing**.....15
  - Size and Weight Restrictions .....15
  - Guides for Selecting Processing .....15
- **Preparing to Print**.....16
  - Setting Up the Paper Feed Tray .....16
  - Adding or Replacing Paper .....16
  - Setting Up the Paper Receiving Tray.....17
  - Closing the Paper Receiving Tray.....18

# Paper Recommendations

## Size and Weight Restrictions

Printing paper sizes of 4" × 6" (postcard size, or A6) to 11" × 17" (ledger or A3) can be used. A wide range of paper thicknesses and types can be used for printing. Use printing paper with weights between 13-lb bond (46 g/m<sup>2</sup>) and 110-lb index (210 g/m<sup>2</sup>).

The maximum printing area is as follows:

- Ledger Cylinder (Drum) - 10.7" × 16.5" (273 × 420 mm)
- A3 Cylinder (Drum) - 11.4" × 16.2" (290 × 412 mm)

### Important!

**Do not use the following types of paper, as they can cause jams or misfeeds:**

- Extremely thin paper (less than 13-lb bond, or 46 g/m<sup>2</sup>)
- Extremely thick or heavy paper (greater than 110-lb index, or 210 g/m<sup>2</sup>)
- Wrinkled, curled, folded, or torn paper
- Chemically treated or coated paper (such as thermal or carbon paper)

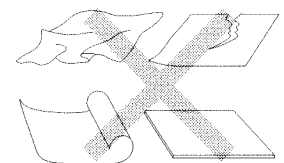
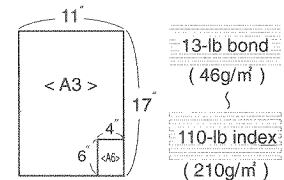

14

## Guides for Trouble-Free Use

**To prevent paper jams and misfeeds, follow the directions below:**

- When using standard paper, set the Paper Feed Pressure Adjustment Lever to "NORMAL" and open all four Paper Arrangers. **pp. 16-18**
- When using thick paper (such as card stock), set the Paper Feed Pressure Adjustment Lever to "CARD," and open the two inner Paper Arrangers. **pp. 16-18**
- When using slippery paper, set the Paper Feed Pressure Adjustment Lever to "CARD." **p. 16**
- Slide the Feed Tray Paper Guides, Receiving Tray Paper Guides, and Paper Stop to fit the paper size. **pp. 16-18**
- Use flat printing paper that is free of folds. If curled paper is unavoidable, place the printing paper so that the curl faces down.
- Paper may stick to the Cylinder (Drum) surface if the top margin is too narrow on the original or if the upper portion of the original uses a large amount of ink. To solve this problem, lower the print position to provide a wider top margin or reverse the top and bottom of the original. Then restart printing from the beginning. **p. 33**

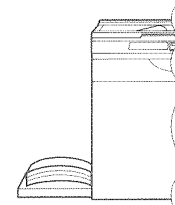

## Storing Environment

Store printing paper in a level, dry area. Storing the paper in an excessively humid area could cause paper jams as well as poor print quality.

After unpacking printing paper, keep the remaining paper wrapped and store it in a moisture-proof box. It is highly recommended to put silica gel in the paper storage box.

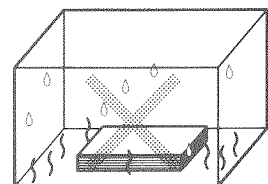

# Originals and Processing

## Size and Weight Restrictions

The Stage Glass can be used to print from bound originals or sheet originals. You can place originals from 2" × 3 1/2" (business card, 50 × 90 mm) size to 11" × 17" (ledger size, or A3) on the Stage Glass. The weight of bound originals should be 22 lb (10 kg) or less.

The margins indicated on the figure to the right are required for the original. Reduce the original if necessary to fit it inside these margins.

- NOTE**
- If an original is wrinkled, curled, or creased, flatten it thoroughly so that the originals can be pressed directly onto the Stage Glass during processing.
  - If correction fluid or glue is used on an original, thoroughly dry it before you place the original on the Stage Glass.

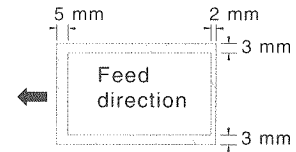
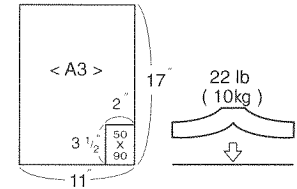

## Guides for Selecting Processing

You can use various image processing modes to produce printed copies according to the contents of the original.

- L/P Key (LINE/PHOTO) - ( p.24)
  - LINE For ordinary documents with lines and text.
  - PHOTO To reproduce different shades of photo or half-tone images.
  - DUO To reproduce photo or half-tone images clearly without deteriorating line sharpness.
- PHOTO CONTRAST Enhancement Key (LIGHT/DARK) - ( p.31)
  - LIGHT To decrease shades of a photo original.
  - DARK To increase shades of a photo original.
- DOT PHOTO Selection Key (DOT /DOT /DOT ) - ( p.31)
  - To process a photo original using a dot screen.
- BOUND ORIGINAL Selection Key (PHOTO/ERASE) - ( p.32)
  - PHOTO To print a two-page spread of a bound original on one sheet with the binding shadow lightened.
  - ERASE To print a two-page spread of a bound original on one sheet with the binding shadow erased.

# Preparing to Print

## Setting Up the Paper Feed Tray

- 1 **Open the Paper Feed Tray.**

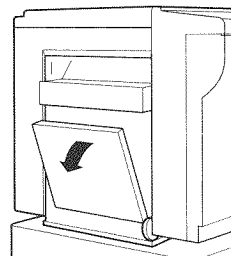

- 2 **Load printing paper and slide the Feed Tray Paper Guides to fit the paper width.**

**Important!**

Do not mix printing paper of different sizes.

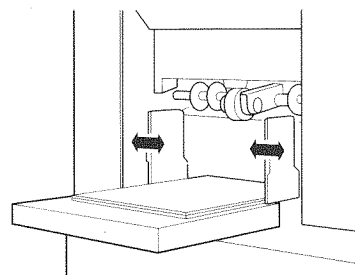

- 3 **Set the paper feed pressure.**

Position the Paper Feed Pressure Adjustment Lever at either "NORMAL" or "CARD," according to the paper to be used.

- NORMAL      Standard paper
- CARD        Thick paper such as card stock

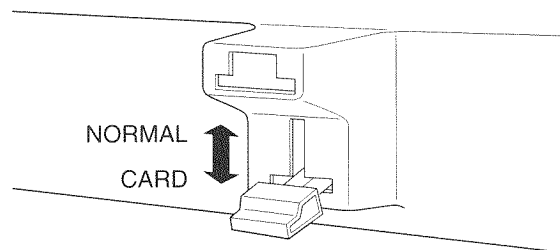

## Adding or Replacing Paper

If you want to add paper or use paper of different size, lower the Paper Feed Tray so that you can load the paper easily.

To lower the Paper Feed Tray, hold down the Feed Tray Down button.

**Important!**

Do not mix different paper sizes in the Paper Feed Tray.

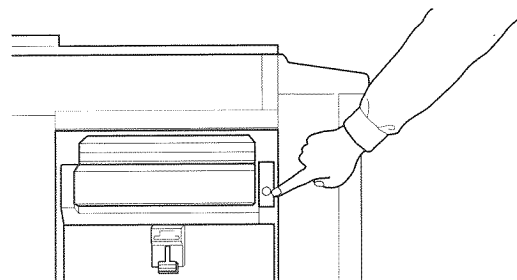

# Setting Up the Paper Receiving Tray

## 1 Open the Paper Receiving Tray.

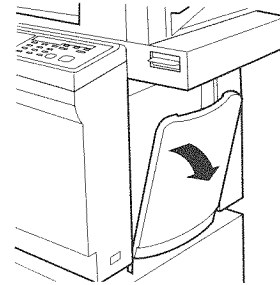

## 2 Raise and slide the Receiving Tray Paper Guides to fit the paper width.

Holding the Receiving Tray Paper Guide Adjustment Knob, slide the guides.

**NOTE** For thick paper, set the guides a little wider than the actual paper width.

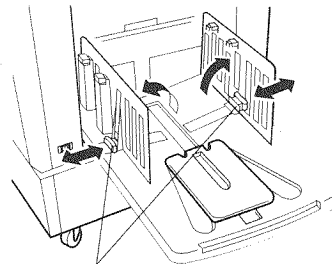

Receiving Tray Paper Guide Adjustment Knob

## 3 Adjust the Paper Arrangers.

Select the best combination of Paper Arranger settings, referring to the following instruction.

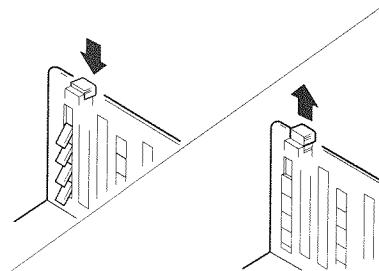

**NOTE** = How to set Paper Arrangers =

• Ordinary paper

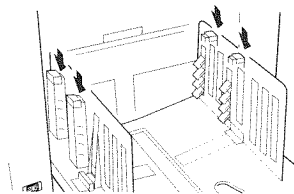

Open all four Paper Arrangers.

• Ordinary paper with images lopsided on page

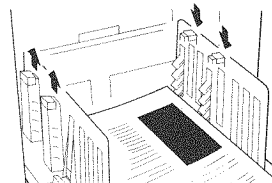

Open two Paper Arrangers on the more heavily printed side.

• Thick paper

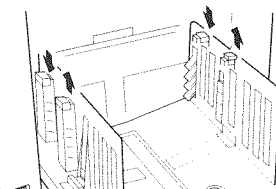

Open two Paper Arrangers closest to the machine.

- 4** Raise and slide the Paper Stop to fit paper length.

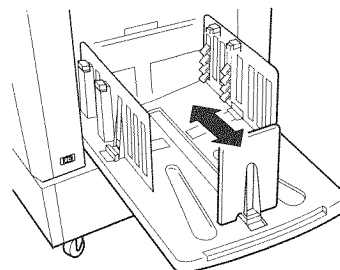

## Closing the Paper Receiving Tray

- 1** Slide the Paper Stop inwards and turn it down and outwards.

**NOTE** Do not let the Paper Stop protrude from the Paper Receiving Tray.

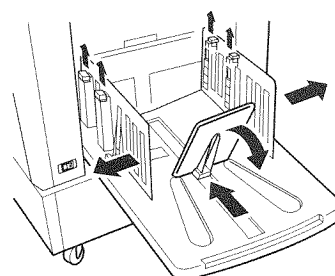

18

- 2** Close all four Paper Arrangers and spread the Receiving Tray Paper Guides to the ledger (A3) position.

- 3** Turn down the Receiving Tray Paper Guides.

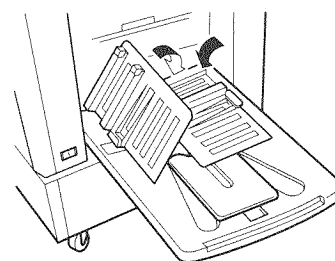

- 4** Close the Paper Receiving Tray.

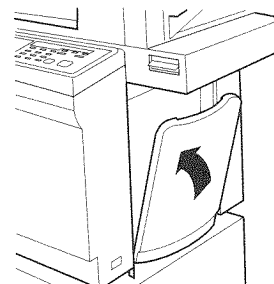



# Basic Features

This section describes the basic operation procedures and the features which are easy to use even for inexperienced operators in order to enhance the utility of your Risograph.

- Cautions Concerning Handling and Operation .....20
- Basic Processes .....21
- Basic Operation .....22
- Photo/Half-Tone Processing **F-1** .....24
- Producing Proof Copies **F-2** .....25
- Automatic Printing **F-3** .....26

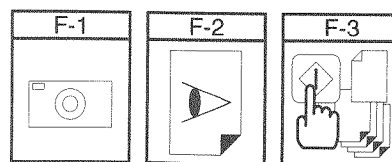

# Cautions Concerning Handling and Operation

To ensure proper product quality and the prolonged life of your Risograph, follow the directions below concerning handling and operation.

## **WARNING [ To Avoid Personal Injury ]**

- Be alert and use common sense.
- Do not open the cover or move the unit during operation.
- Do not handle the parts inside the unit, except what is specified in this *User's Guide*.

The parts are made with high precision and can be damaged easily.

- Never stick your hands or fingers in the openings in and around the Paper Feed Tray as well as the Paper Receiving Tray during operation.
- Keep loose clothing or long hair away from moving parts to avoid becoming entangled.
- Do not try to alter the unit or remove parts.
- Disconnect the power cord if you think there is an electrical problem.
- Before cleaning any parts of the unit, turn the power off.

## **Caution [ To Avoid Mechanical Problems ]**

- Open/close the covers gently.
- Do not turn off or unplug the unit during operation.
- Do not place items on top of the unit or in any opening of the unit during operation. It could cause damage.
- Do not place heavy objects on any part of the unit.
- Do not subject the unit to jolts.
- Contact your local service center before moving the unit.

## **Important! - Materials Not to Be Printed**

Remember not to infringe copyrights or violate laws when using the equipment, even during personal use. Consult your local authorities for further details. In general, use discretion and common sense.

# Basic Processes

The basic processes of your Risograph can be divided into two stages: making a master of an original (master-making), and then printing copies from the master. Your Risograph has been designed so that these two processes flow smoothly from one to the other, with the current action shown clearly in the display.

## Master-Making

When you create a master, an original is scanned. The master is imaged and then automatically placed on the Print Cylinder (Drum).

**1 Set an original in place.**

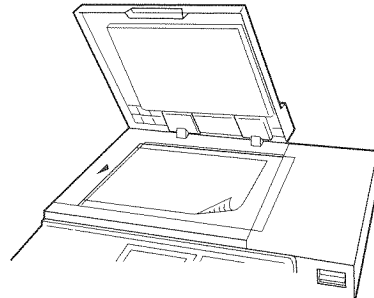

**2 Scan the original.**

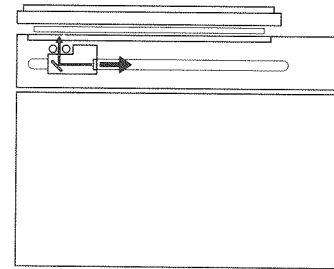

**3 Create a master.**

The master is placed on the Print Cylinder (Drum) and a proof copy is produced.

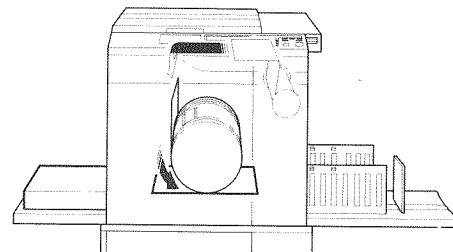

## Printing

When you print, the Print Cylinder (Drum) rotates to print the specified number of copies.

**4 Enter the number of copies you want.**

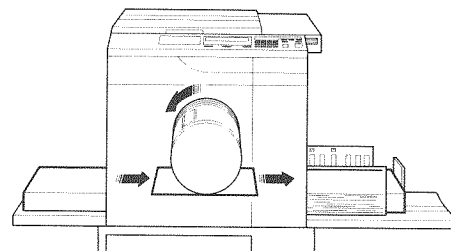

**5 Start printing.**

# Basic Operation

## 1 Turn the power switch ON.

The power switch is located on the lower right side of the machine.

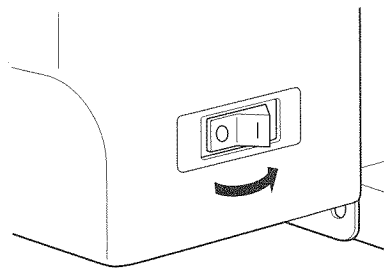
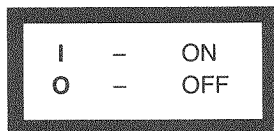

## 2 Check the settings on the control panel.

When the power is connected, the Main Display and control panel indicators show the initial settings.

Make any necessary changes, such as reproduction ratio and processing mode.

**Holding down the R •  $\%V$  (ALL RESET) key longer than one second returns the control panel to the initial settings.**

- ☛ p.36 ...Return to initial settings.
- ☛ p.52 ....You can customize the initial settings.
- ☛ p.47,48....Frequently used combinations of settings can be saved in memory for quick recall.

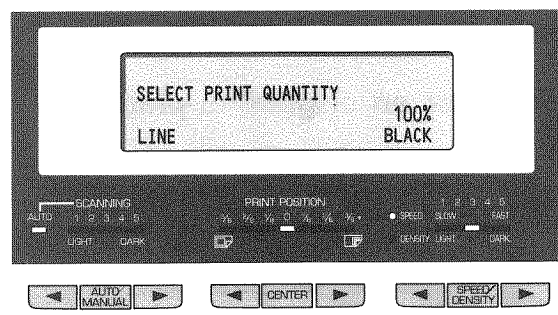

22

## 3 Place an original on the Stage Glass.

Open the Stage Cover and place an original face down. Position the original according to the indicators on the left-hand side of the glass. Close the cover, resting it gently on the original.

**⚠ Caution** Do not force the cover down on top of a bound original placed on the Stage Glass.

**NOTE** When an original is in place, processing automatically changes to Master-Making from Printing. The "READY TO MAKE MASTER" message appears in the Main Display while the MASTER-MAKING indicator on the control panel lights.

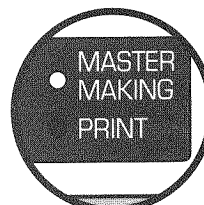
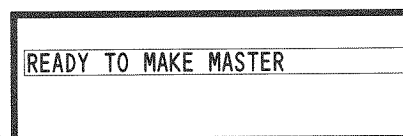
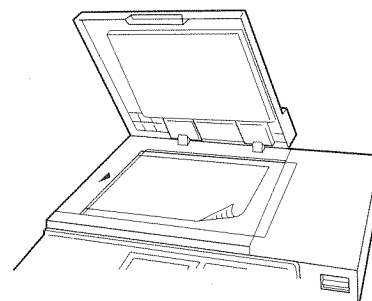

## 4 Press the **START** key.

After an original is scanned, a master is created. A sample is automatically printed to allow you to check the print quality, position, and density.

- ☞ **p.33** .....To change the position of the printed image, press the PRINT POSITION Adjustment keys, and/or turn the Left/Right Print Position Adjustment Dial.
- ☞ **p.35** ....To change the density of the printed copies, change the print density setting.

If settings are changed, press the TEST PRINT key to check the results with sample prints.

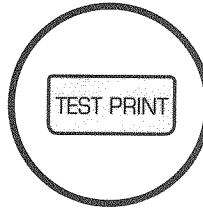
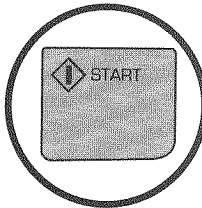

## 5 Enter the number of copies to be printed.

Specify the number of copies to be printed using the Print Quantity keys; the number is displayed in the Print Quantity Display.

**NOTE** If you enter a number incorrectly, press the C key to reset the Print Quantity Display to zero, then enter the correct number.

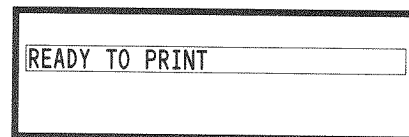
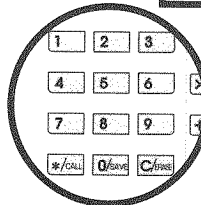
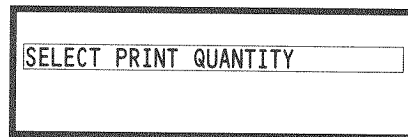

## 6 Press the **START** key.

The specified number of copies is printed.

**NOTE** If printing stops and the "ADD PAPER" message appears in the Main Display, paper has run out in the Paper Feed Tray. Load paper into the tray.  
☞ **p.16**

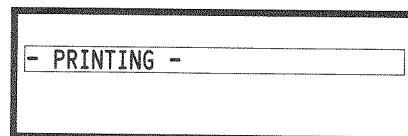
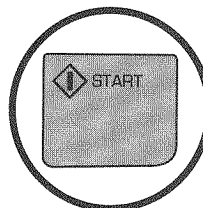

# Photo/Half-Tone Processing

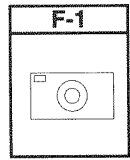

If an original contains photographs or half-tone images, or a multi-colored original is used, select PHOTO or DUO processing by holding down the LINE/PHOTO key. The current selection appears in the Main Display.

Since the image is processed graphically, degrees of shading are accurately reproduced.

## PHOTO

Reproduces different shades of photograph or half-tone images most clearly.

Lines and texts become less sharp if they are included in an original.

## DUO

Reproduces photograph or half-tone images clearly without deteriorating the sharpness of lines and texts.

This processing mode is recommended for multi-colored originals or photo originals with sharp lines and texts included.

**p.30**.....The scanning contrast setting should be checked and adjusted according to image density, if necessary.

- NOTE**
- If DUO is selected for light-density originals, lines might be broken. In this case, select LINE.
  - If LINE is selected to print an original that contains a darkly shaded photograph, on the other hand, copies might be smudged. In this case, select PHOTO or DUO.
  - The Digitizer III (optional) cannot be used simultaneously with the duo processing mode.

**Holding down the R • 3 (ALL RESET) key longer than one second returns processing to the initial setting.**

**p.47, 48**.....The selected processing can be saved in memory for quick recall.

**p.52**.....You can customize initial settings.

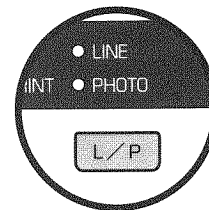
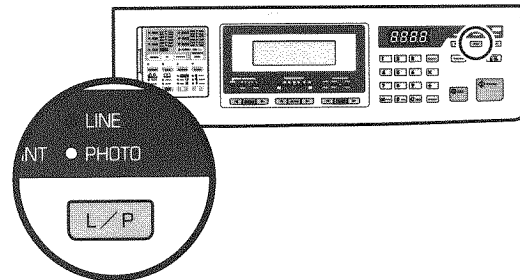

# Producing Proof Copies

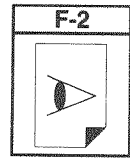

If changes have been made to the print position and other settings, check the print quality by producing proof copies.

By holding down the TEST PRINT key, you can print continuously.

**NOTE** Test printing does not affect the quantity in the Print Quantity Display.

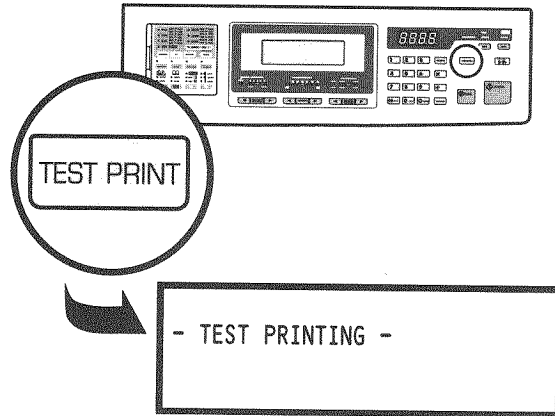

# Automatic Printing

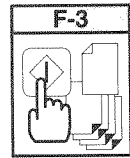

If you do not need to check print samples before making prints, press the AUTO PRINT key before pressing the START key to activate the Auto Print feature. This feature enables nonstop operation from master-making through printing.

**NOTE** If you need to check or adjust the print position, cancel the Auto Print feature by pressing the AUTO PRINT key again.

26

## 1 Press the AUTO PRINT key.

The Auto Print Indicator lights and the "AUTO PRINT" message appears in the Main Display.

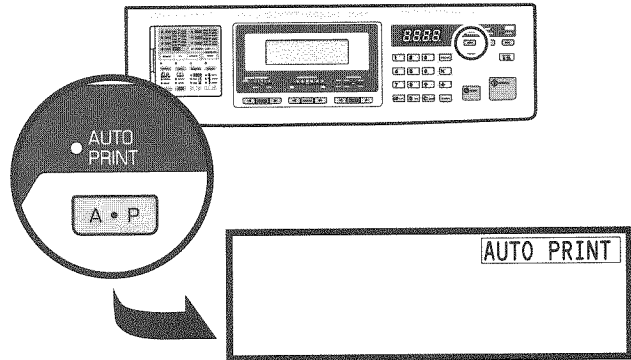

## 2 Set an original into place.

Open the Stage Cover and place an original face down on the Stage Glass. Close the cover gently on the original.

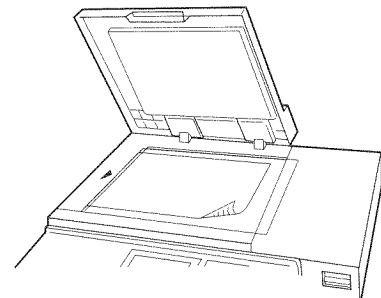

## 3 Enter the number of copies to be printed.

**NOTE** If you enter a number incorrectly, press the C key to reset the Print Quantity Display to "0," then enter the correct number.

If "0" is selected as the print quantity, the machine will not start.

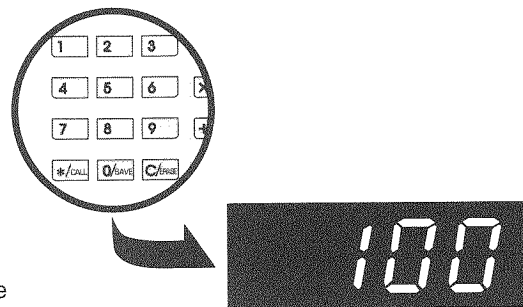

## 4 Press the START key.

The specified number of copies are produced with an extra proof copy.

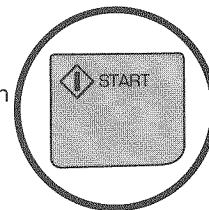

**p.47,48** .....The Auto Print feature can be saved in memory for quick recall.

**Holding down the R • ⌵ (ALL RESET) key longer than one second returns the Auto Print feature to the initial setting.**

**p.52** .....You can customize initial settings.



# Adjustment Features

This section describes the features that enhance your Risograph's capabilities.

- **Reducing and Enlarging Originals** **F-4** .....28
  - Using Preset Reduction and Enlargement .....28
  - Using Zoom .....29
- **Changing Image Contrast on Prints** **F-5** .....30
- **Producing Enhanced Prints**.....31
  - Producing Enhanced Photo Images **F-6** .....31
  - Producing Dotted Images **F-7** .....31
- **Reproducing Bound Documents** **F-8** .....32
- **Repositioning the Print** **F-9** .....33
  - Adjusting Vertical Print Position .....33
  - Adjusting Horizontal Print Position .....33
- **Changing Print Speed** **F-10** .....34
- **Changing Print Density** **F-11** .....35
- **Return to Initial Settings** **F-12** .....36

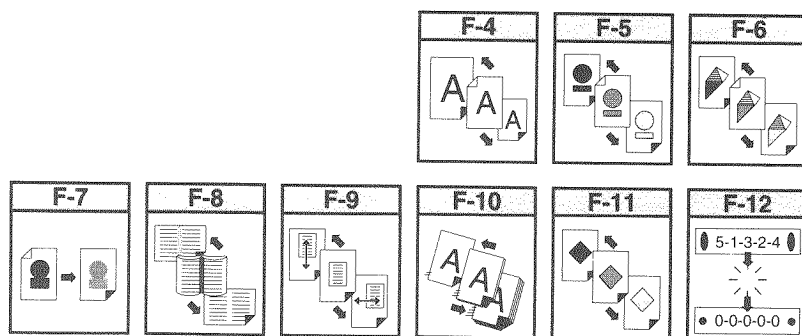

# Reducing and Enlarging Originals

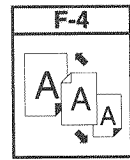

Originals can be reduced or enlarged, using either preset reduction and enlargement or zoom that you specify.

Press the PRESET SIZE/ZOOM Selection key to select the method that you want to use: Preset Reduction/Enlargement or Zoom. To switch back, press the key again.

(When the Zoom is available, the "ZOOM" message appears in the Main Display next to the Reproduction percentage.)

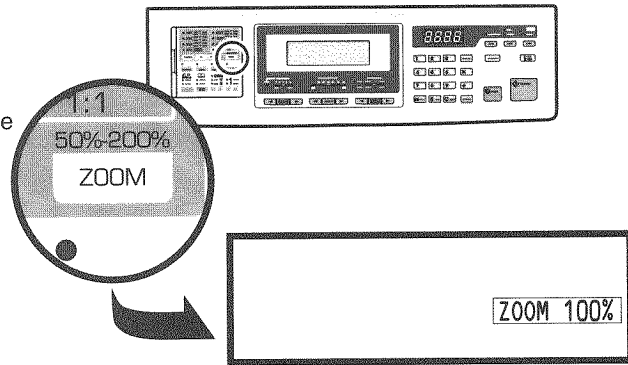

☞ p.47, 48 .....Reproduction percentage can be adjusted and saved in memory for quick recall.

28

## Using Preset Reduction and Enlargement

To reduce or enlarge any standard-size original to another standard size, use the Preset Size method. Seven Preset Reduction and Enlargement percentages are available any time that the "ZOOM" message does not appear in the Main Display. If selected, the chosen percentage appears in the Main Display, and the Preset Reduction/Enlargement Size indicator in the Sub Control Panel lights up.

= Metric Model =

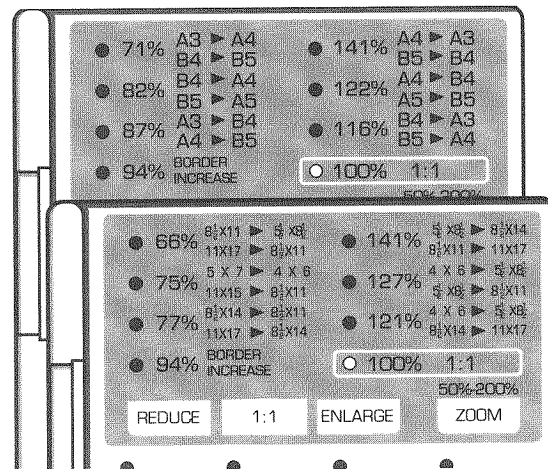

= USA Model =

**1** Confirm that the "ZOOM" message does not appear in the Main Display.

If the "ZOOM" message appears, press either the PRESET SIZE/ZOOM Selection key or the 1:1 key to activate the Preset Reduction/Enlargement Size indicators.



**2** Press the **REDUCE** or **ENLARGE** key to select a desired percentage.

Each time the REDUCE or ENLARGE key is pressed, the indicators light and the percentage appearing in the Main Display changes in the following order:

< USA model >

94% → 77% → 75% → 66% → 94%  
121% → 127% → 141% → 121%

< Metric model >

94% → 87% → 82% → 71% → 94%  
116% → 122% → 141% → 116%

When you press the 1:1 key, the percentage returns to the original size (100%).

Holding down the R •  $\frac{1}{2}$  (ALL RESET) key longer than one second returns print size to the initial setting (1:1).

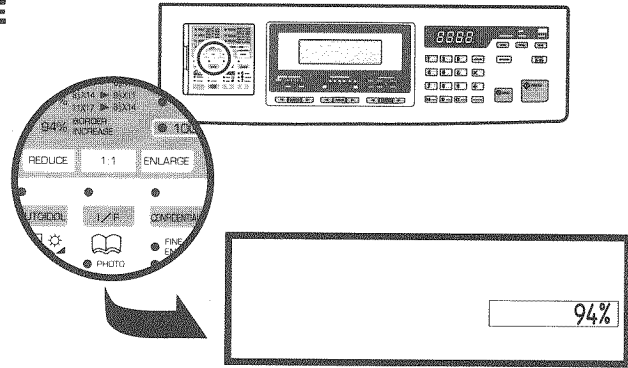

## Using Zoom

You can specify any reduction or enlargement between 50% and 200%.

**NOTE** When you press the 1:1 key, "ZOOM" disappears from the Main Display and the percentage returns to the original size (100%).

**1** Confirm that the **"ZOOM"** message appears in the Main Display.

If a Preset Reduction/Enlargement Size indicator is lit, press the PRESET SIZE/ZOOM Selection key. The current reproduction percentage is shown in the Main Display.

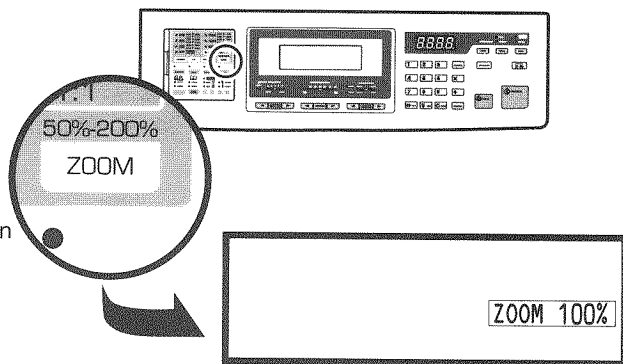

**2** Press the **REDUCE** or **ENLARGE** key to specify the desired percentage in the Main Display.

Each time you press the REDUCE or ENLARGE key, the percentage in the Main Display decreases or increases by 1%.

Holding down the key longer than one second changes the percentage continuously.

Holding down the R •  $\frac{1}{2}$  (ALL RESET) key longer than one second returns the print size to the initial setting (1:1).

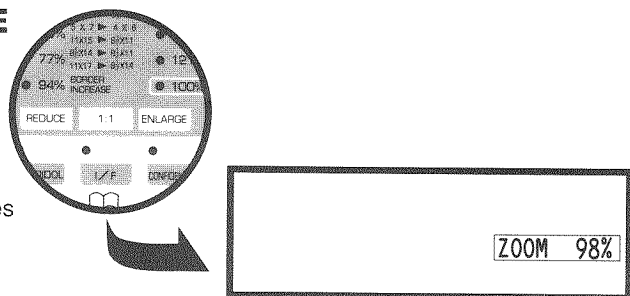

# Changing Image Contrast on Prints

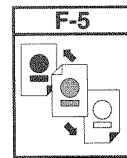

To achieve different tones on printed copies from those of an original, adjust the scanning contrast manually by canceling the Auto Scanning Contrast Adjustment mode.

**NOTE** The Auto Scanning Contrast Adjustment mode is available only for the Line processing mode.

When the Auto Scanning Contrast Adjustment mode is selected, the Auto adjustment indicator is lit. In this case, the scanning contrast will be adjusted automatically according to the darkness of the original scanned.

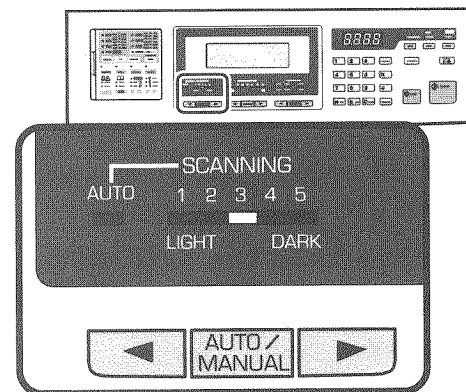
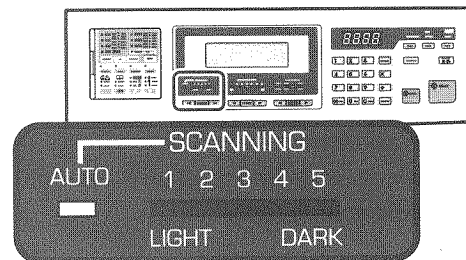

30

## 1 Confirm that the Auto adjustment indicator is OFF.

If not, press the SCANNING CONTRAST Mode key to switch to the manual adjustment mode.

## 2 Press the ◀ key to lighten or the ▶ key to darken.

Each press of the ◀ or ▶ keys lightens or darkens, respectively, the contrast by one degree (on a 1 to 5 scale).

◀ For newspaper or colored originals.

▶ For poor copies or pencil-written originals.

**NOTE** After adjusting the scanning contrast, make another master to make the adjustment effective for further printed copies.

Holding down the R•⌂ (ALL RESET) key longer than one second returns the Scanning Contrast Adjustment mode to the initial setting (AUTO).

☛ p.47, 48 ....Scanning contrast can be adjusted and saved in memory for quick recall.

# Producing Enhanced Prints

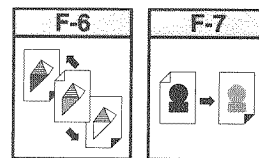

You can enhance photograph or half-tone images on an original copy in two ways: adjusting shades in images and processing images with a dot screen.

## Producing Enhanced Photo Images

Press the PHOTO CONTRAST Enhancement key in the sub control panel.

When this feature is selected, the corresponding indicator lights and "▲" or "▼" appears in the Main Display.

- LIGHT: Decreases shades in darker photograph.
- DARK: Increases shades in whitish photograph.

**NOTE** This feature is not available in the line processing mode.

Holding down the R•%v (ALL RESET) key longer than one second returns processing to the initial setting.

☞ p.47, 48 .....The selected processing can be saved in memory for quick recall.

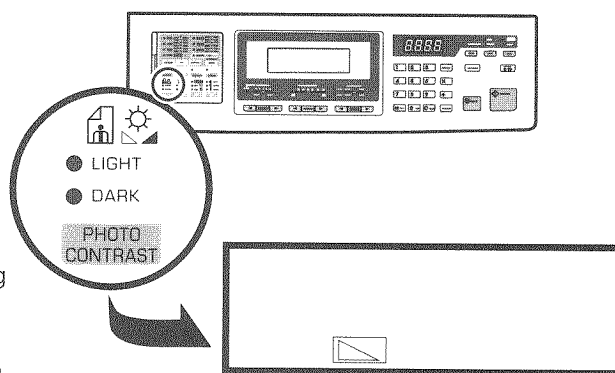

## Producing Dotted Images

Press the DOT PHOTO Selection key in the sub control panel.

When this feature is selected, the corresponding indicator lights and "DOT" (, or )" appears in the Main Display.

- DOT ( ) - Sparse dot pattern
- DOT ( ) - Fine dot pattern
- DOT ( ) - Super fine dot pattern

**NOTE** This feature is not available in the line processing mode.

Holding down the R•%v (ALL RESET) key longer than one second returns processing to the initial setting.

☞ p.47, 48 .....The selected processing can be saved in memory for quick recall.

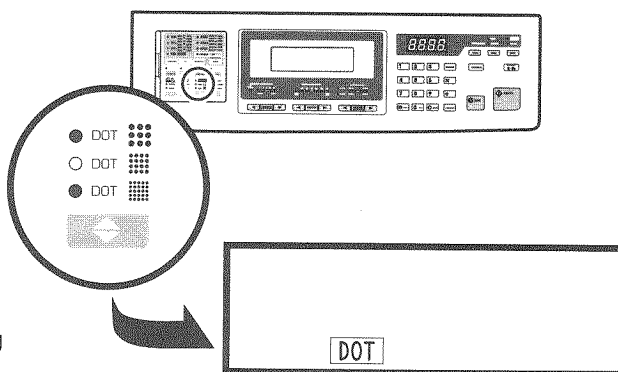

# Reproducing Bound Documents

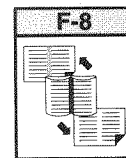

The Bound Original feature can be used to process originals that are printed on facing pages of a book, such as an atlas, printed report, or other types of bound originals. When this feature is active, the binding "gutter" shadow can be lightened or erased.

Press the BOUND ORIGINAL Selection key to select either PHOTO or ERASE; the corresponding indicator will light and the corresponding message will appear in the Main Display.

## PHOTO

Lightens the binding "gutter" shadow between the facing pages of a bound original. Images in the shadow will not be erased.

## ERASE

Removes the "gutter" shadow between the facing pages of a bound original.

- NOTE**
- If the bound original has no margins around the edges, cancel the Bound Original feature. Otherwise, some printed images could be incomplete.
  - This feature is not available in the duo processing mode.

☛ p.47, 48 .....The selected processing can be saved in memory for quick recall.

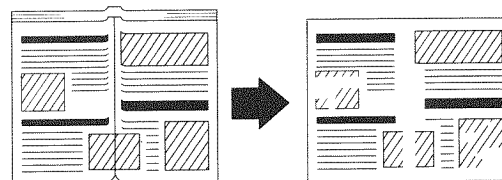
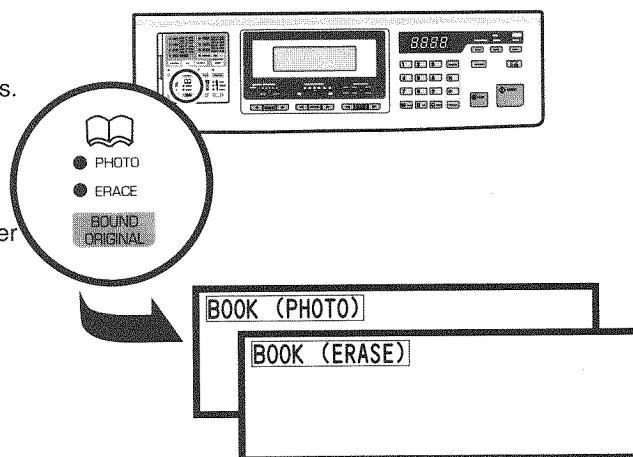

# Repositioning the Print

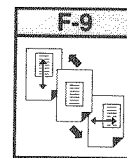



The print position can be adjusted vertically (up and down) and horizontally (to the right and left).

**NOTE** If you adjust the print position, be sure to produce test prints to verify the new print position.

## Adjusting Vertical Print Position

You can move the print position vertically by pressing either of the PRINT POSITION Adjustment keys. The allowable range is  $\pm 3/8"$  ( $\pm 10$  mm).

When the key is pressed, the distance of print position shift appears in the Main Display and the adjusted vertical print position is roughly given by the PRINT POSITION indicator.

-  Moves print position down.
-  Moves print position up.
-  Returns print position to the center.

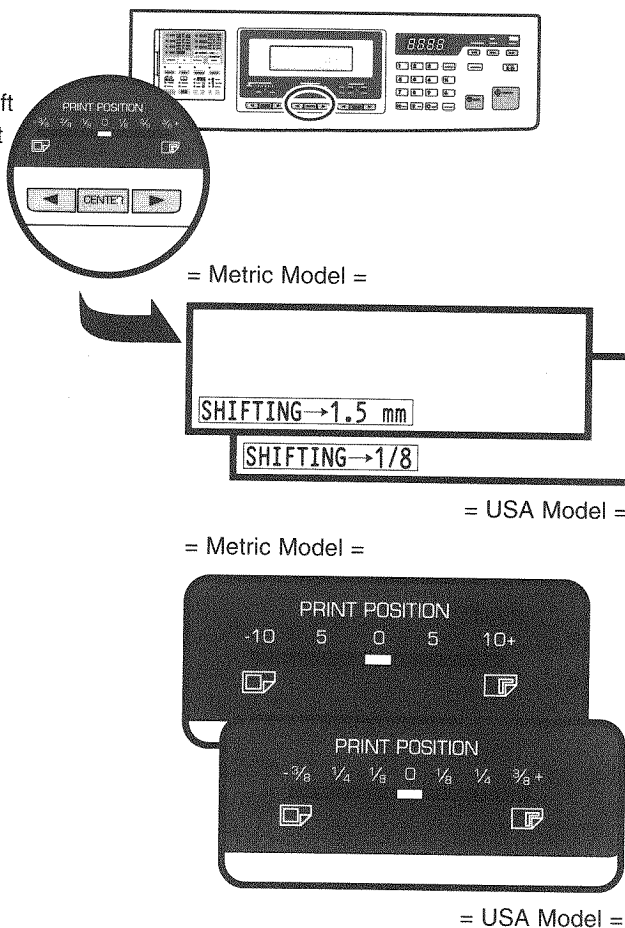

## Adjusting Horizontal Print Position

You can move the print position horizontally by turning the Left/Right Print Position Adjustment Dial on the Paper Feed Tray. The allowable range is  $\pm 3/4"$  ( $\pm 20$  mm).

- [UP] : Moves print position to the left.
- [DOWN] : Moves print position to the right.

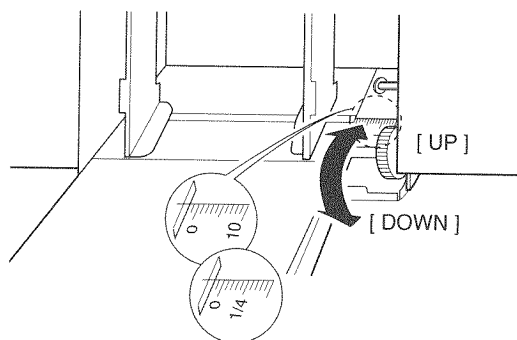

# Changing Print Speed

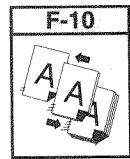

Print speed can be set at any of five levels, ranging between 60 and 120 sheets per minute.

## 1 Press the **PRINT SPEED/DENSITY Selection** key and select the **SPEED** mode.

When the **SPEED** indicator is lit, you can change print speed.

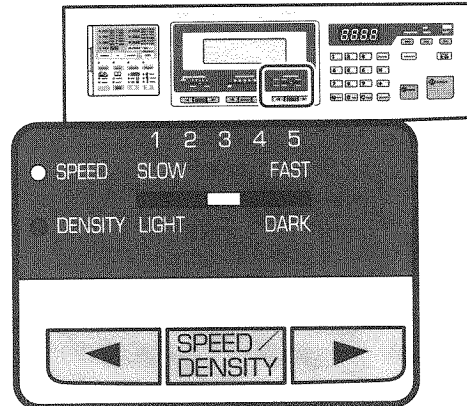

## 2 Press the **PRINT SPEED Adjustment** keys (◀/▶) to change print speed.

◀ Decreases print speed.

▶ Increases print speed.

**NOTE** The normal speed (setting 3) is 100 sheets per minute.

☛ **p.47, 48** .....Print speed setting can be saved in memory for quick recall.

**Holding down the R • ⌘ (ALL RESET) key longer than one second returns print speed to the initial setting.**

☛ **p.52** .....You can customize initial settings.

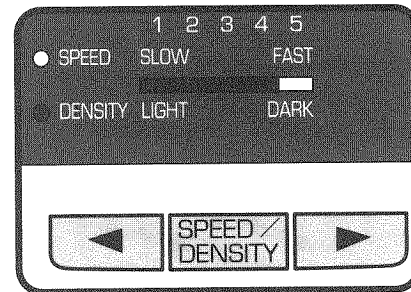



# Changing Print Density

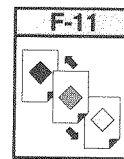

Print density can be set at any of five levels.

## 1 Press the PRINT SPEED/ DENSITY Selection key and select the DENSITY mode.

When the DENSITY indicator is lit, you can change print density.

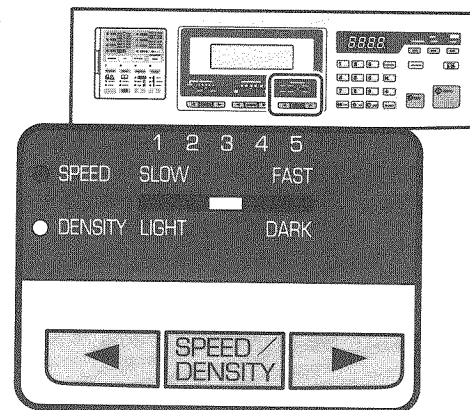

## 2 Press the PRINT DENSITY Adjustment keys (◀/▶) to change print density.

◀ Makes print density lighter.

▶ Makes print density darker.

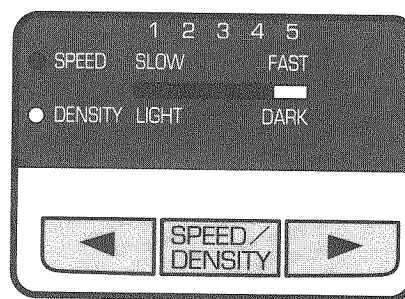

☞ p.47, 48 .....Print density setting can be saved in memory for quick recall.

When the print density setting is changed, press the TEST PRINT key to check the results with proof copies.

**NOTE** If the print density levels do not provide the desired result, adjust scanning contrast and create another master.

☞ p.30

Holding down the R•% (ALL RESET) key longer than one second returns print density to the initial setting.

# Return to Initial Settings

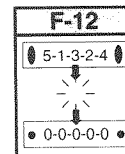

To return all the settings to initial status, including print position and reproduction percentage, turn the power off and on again, or hold down the R •  (ALL RESET) key for more than one second.

**NOTE** If you have customized the initial settings, they will be the ones recovered when you perform the procedure above.

See p.52

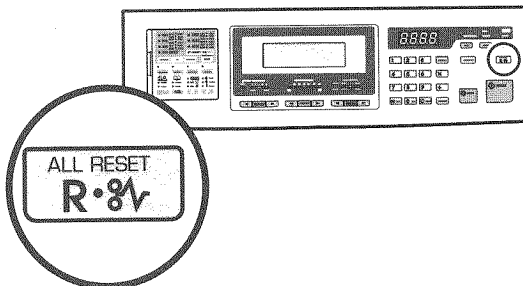

## INITIAL SETTINGS (at time of purchase)

36

- Image Processing Mode Select

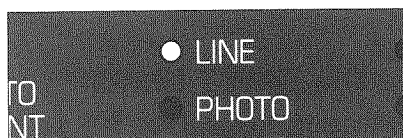

- Size Adjustment

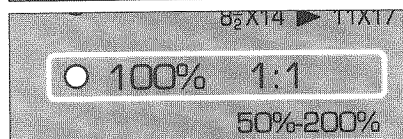

- Print Quantity Display

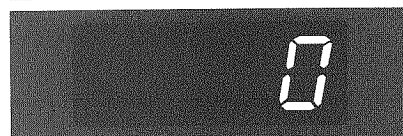

- Print Speed/Density

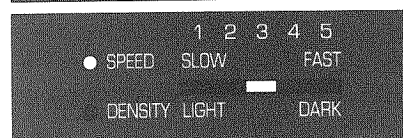

- Print Position

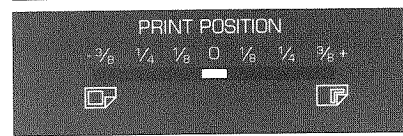

- Master-Making/Print

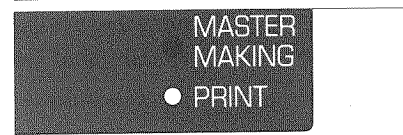

- Original Scanning Contrast

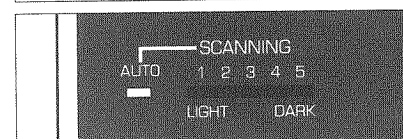

- Main Display

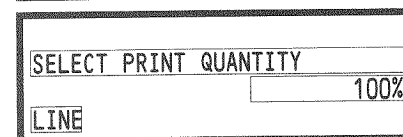

# Special Features

This section describes special features that may be used for special needs.

- **Printing Originals Side by Side** .....38
  - Printing the Same Original Two-Up **F-13** .....38
  - Printing Two Different Originals Two-Up **F-14** .....39
- **Automatic Sorting into Groups** .....41
  - Setting Up Program A **F-15** .....42
  - Setting Up Program B **F-16** .....44
- **Storing Settings in Memory** **F-17** .....46
  - Saving Settings .....47
  - Recalling Saved Settings .....48
  - Deleting Saved Settings .....49
- **Protecting Confidential Documents** **F-18** .....50
- **Automatic Idle** **F-19** .....51
- **Customizing the Initial Settings** **F-20** .....52
- **Changing Print Color** **F-21** .....54
  - Changing Print Cylinders (Drums) .....54
- **Interfacing with a Computer** **F-22** .....56

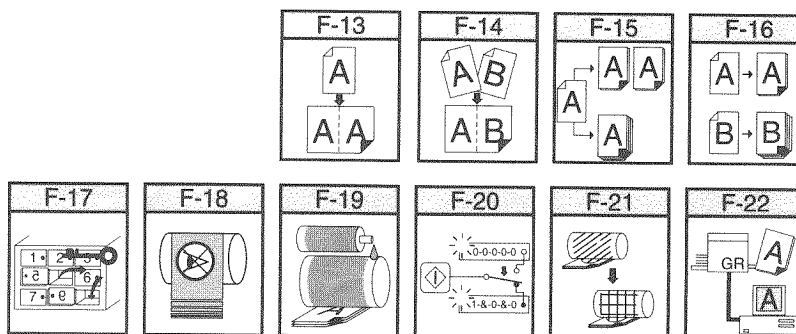

# Printing Originals Side by Side

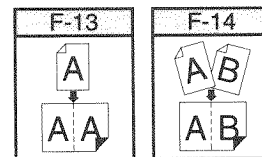

Two of the same (or two different) originals can be printed side by side and, if required, each original can have different settings: reproduction size (Reduce/Enlarge), scanning contrast, and processing (Line/Photo/Duo or Dot Photo).

☛ **p.47, 48** .....Frequently used combinations of settings can be saved in memory for quick recall.

Productivity can be doubled by cutting or folding the Two-Up prints in half to finish your job.

☛ **p.26** .....The Auto Print feature can be used with Two-Up printing.

☛ **p.47, 48** .....The Two-Up feature can be saved in memory for quick recall.

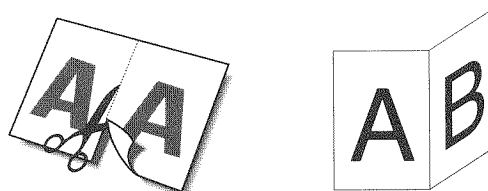

**NOTE** Irregular size printing paper cannot be used with the Two-Up feature.

Holding down the **R•R** (ALL RESET) key longer than one second returns the control panel to the initial settings.

## Printing the Same Original Two-Up

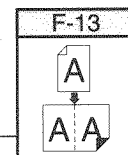

### 1 Press the **TWO-UP** key to activate the Two-Up feature.

The Two-Up indicator lights and the "2UP" message appears in the Main Display when the feature is active.

**NOTE** To cancel the Two-Up feature, press the key again.

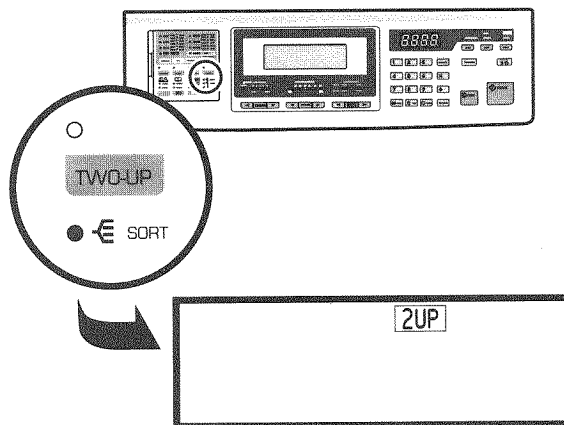

### 2 Place an original face-down on the Stage Glass.

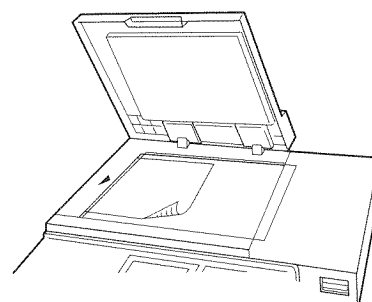

### 3 Press the **START** key.

The original is scanned twice and the Two-Up master is made. A sample Two-Up print is made.

**NOTE** If a 15-second beep sounds and a copy is produced that is half blank, change the initial setting of the Two-Up feature to cancel the interval time.

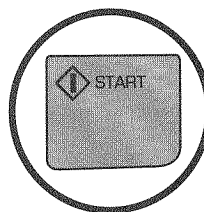

# Printing Two Different Originals Two-Up

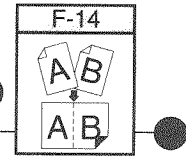

Normally you can make Two-Up prints from two different originals by placing them on the Stage Glass side by side.

If bound documents are used, or if different settings are required for two originals, however, place them on the Stage Glass individually. The Risograph scans the first original, and then provides a 15-second period (a beep sounds) within which to place the second original.

**NOTE** If you press the STOP key or do not place the second original during the 15-second period, the sample print will be produced with one side blank.

- 1 Change the initial setting of the Two-Up feature to provide a 15-second interval for placing the second original.**

☞ p.52

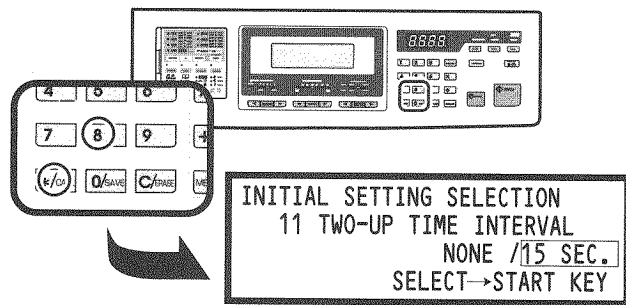

- 2 Press the TWO-UP key to activate the Two-Up feature.**

The Two-Up indicator lights and the "2UP" message appears in the Main Display when the feature is active.

**NOTE** To cancel the Two-Up feature, press the key again.

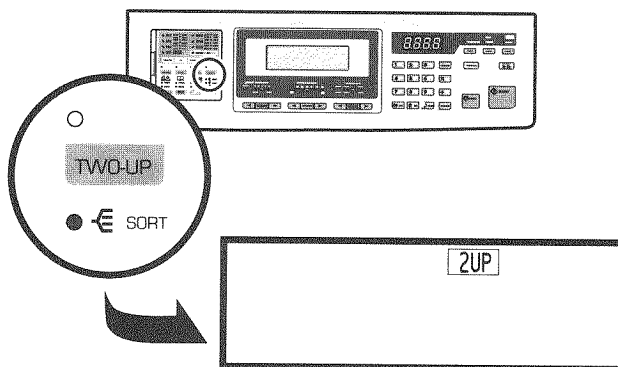

- 3 Place an original face-down on the Stage Glass.**

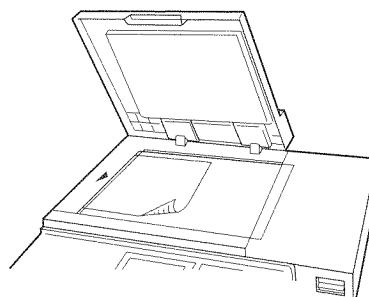

- 4 Press the START key.**  
After the first original is scanned, a 15-second beep sounds.

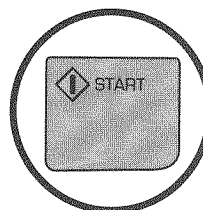

- 5** During the 15-second beep, enter the settings for the second original, if necessary, and place the second original on the Stage Glass.

After the second original is scanned, a sample Two-Up print is automatically printed.

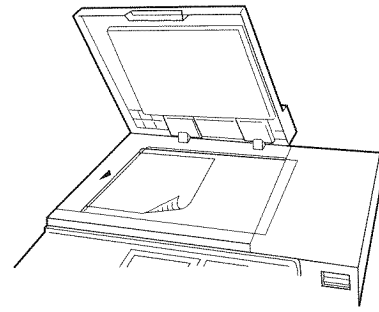

# Automatic Sorting into Groups

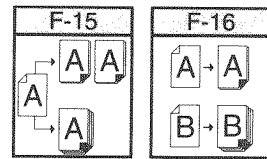

The Programmed Printing feature can be used to print and sort printed sheets into various groups automatically. One of two programmed printing methods, Program A or B, can be selected using the PROGRAM key.

- ☞ **p.47, 48** .....Frequently used combinations of settings can be saved in memory for quick recall.
- ☞ **p.47, 48** .....The Programmed printing setting can be saved in memory for quick recall.

**NOTE** Up to 50 groups can be set up, with a maximum of 9999 copies in each group.

**NOTE** The Job Separator (optional) is useful for Programmed printing.

## Program A

One original is printed in different quantities.

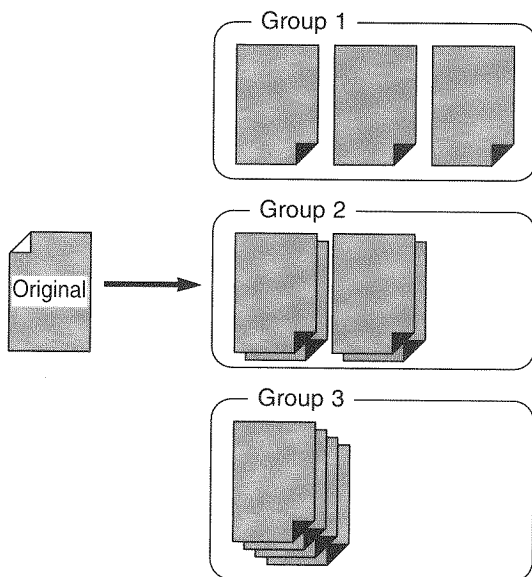

## Program B

Different originals are printed in different quantities.

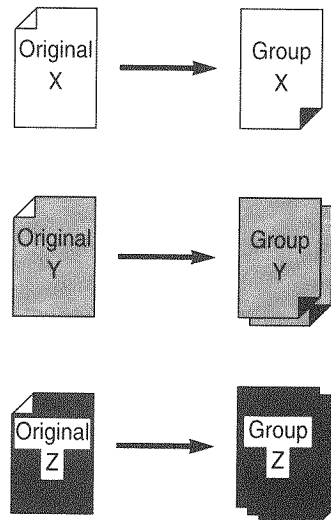

If more than one original (up to 50 sheets) is placed in the ADF Unit (optional) with the Auto Print feature activated, the program set up for Program A runs completely for each original, until all the originals are printed and sorted into groups as specified in the program.

# Setting Up Program A

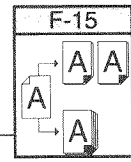

## 1 Press the PROGRAM key.

The Program A entry stage appears in the Main Display.

**NOTE** To cancel Program A, press PROGRAM key again.

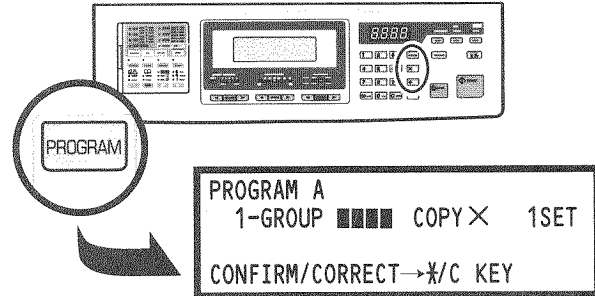

## 2 Input the number of copies to be printed for each cluster of the first group using the Print Quantity keys.

**NOTE** If you enter a number incorrectly, press the "C" key to reset the Print Quantity Display to zero, then enter the correct number.

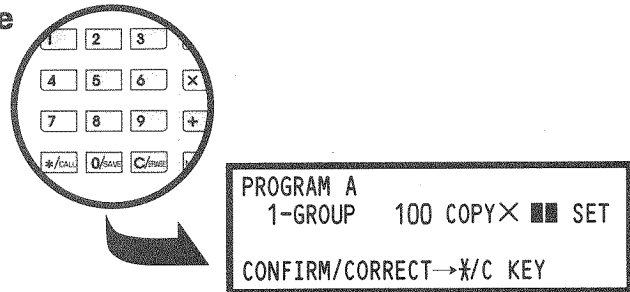

## 3 Press the "X" key and input the number of clusters of the first group.

If you press the "+" key instead of the "X" key at this stage, the quantity is automatically set at "1."

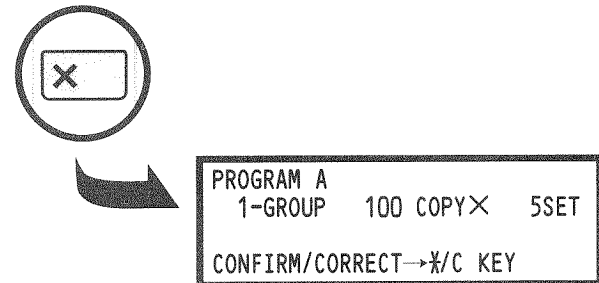

## 4 Press the "+" key to set the print quantity for the second group.

The entry stage for the second group appears in the Main Display.

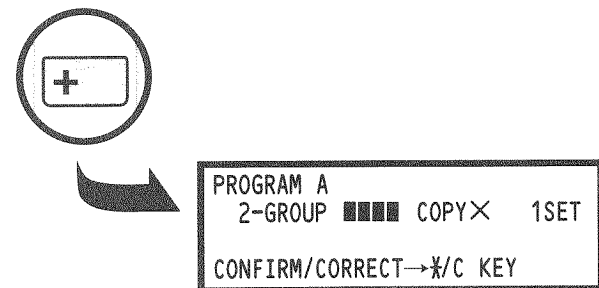

## 5 Use the Print Quantity keys, "X" key and "+" key and input print quantities and cluster numbers for any remaining groups.

Up to 50 groups can be specified.

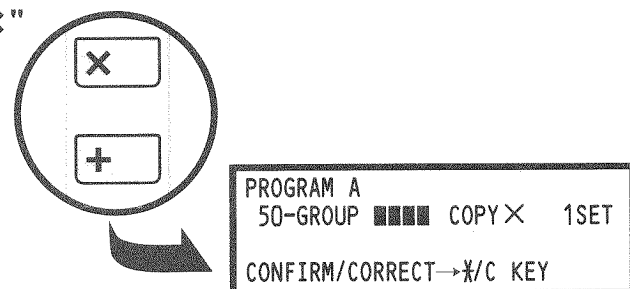

**NOTE** If the PROGRAM key is pressed before a print quantity is specified for the last group, all the Program A settings will be canceled.



## 6 Press the "✳" key to check or correct the number of clusters and copies to be printed for any group already set up.

Each time you press the "✳" key, the entry stage for the previous group is displayed.

**NOTE** If you incorrectly enter the number of clusters and/or copies for the displayed group, press the "C" key to initialize the entry stage, then enter the correct numbers.

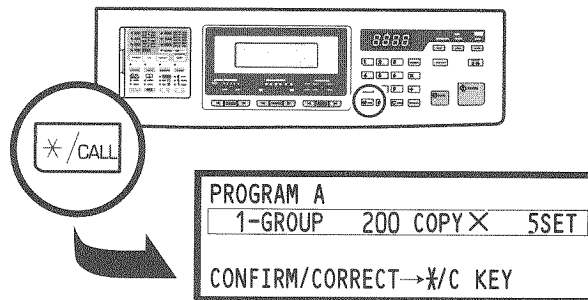

## 7 Enter other settings for Program A.

Specify printing density, printing position, reproduction size, and so on. (The Two-Up feature can also be specified.)

**NOTE** If you want to print more than one original using the same Program A settings, press the AUTO PRINT key to activate the Auto Print feature.

☞ p.47, 48 .....Before pressing the START key, save the program in memory for quick recall if you use these programmed settings frequently.

## 8 Place an original face-down on the Stage Glass.

**NOTE** If the optional ADF Unit is installed, more than one original can be placed on the ADF Tray.

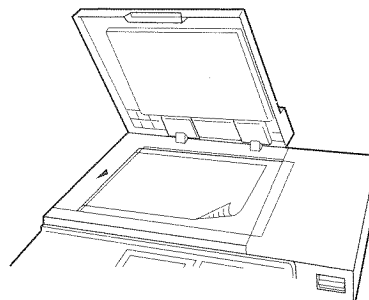

## 9 Press the START key.

A sample print is produced. If the Auto Print feature is not activated, press the START key again.

Copies are produced and sorted according to the program, starting with the last group specified. When printing is completed, the current Program A settings are automatically cleared.

To interrupt the programmed printing, press the STOP key.

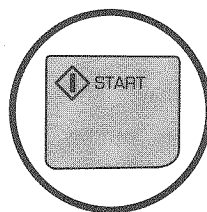

**NOTE** If the Auto Print feature is activated, the current Program A settings are recovered at the end of printing.

Holding down the R • ⌘ (ALL RESET) key longer than one second returns the control panel to the initial settings and clears the program.

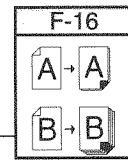

# Setting Up Program B

## 1 Press the PROGRAM key twice.

The Program B entry stage appears in the Main Display.

**NOTE** To cancel Program B, press the PROGRAM key again.

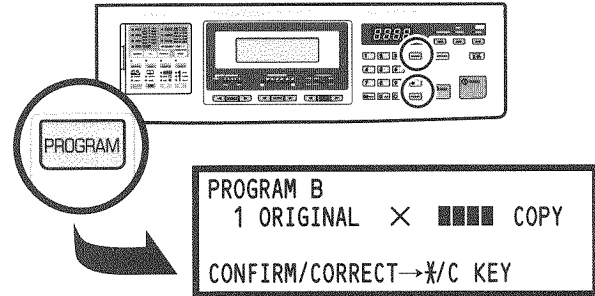

## 2 Input the number of copies to be printed for the first original using the Print Quantity keys.

**NOTE** If you enter a number incorrectly, press the C key to reset the Print Quantity Display to zero, then enter the correct number.

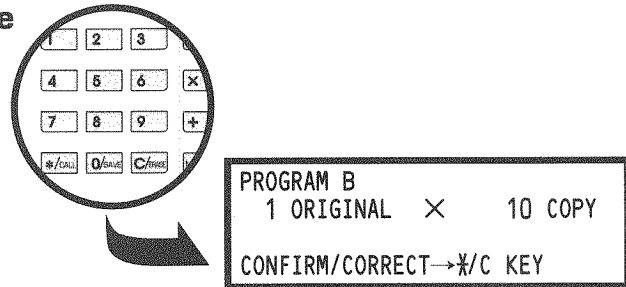

## 3 Press the "+" key to set the print quantity for the second original.

The entry stage for the second original appears in the Main Display.

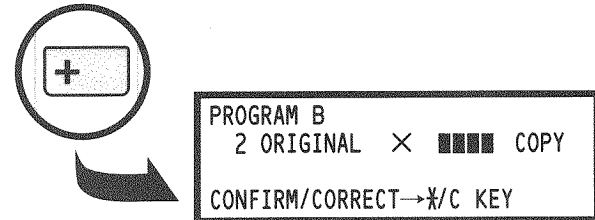

## 4 Input the print quantity for the remaining originals using the Print Quantity keys and the "+" key.

Up to 50 originals can be specified.

**NOTE** If the PROGRAM key is pressed before a print quantity is specified for the last original, all the Program B settings will be canceled.

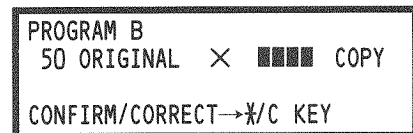

## 5 Press the "✳" key to check or correct the number of copies to be printed for any original already set up.

Each time you press the "✳" key, the entry stage for the previous original is displayed.

**NOTE** If you incorrectly enter the number of copies for the displayed original entry number, press the C key to initialize the entry stage, then enter the correct number.

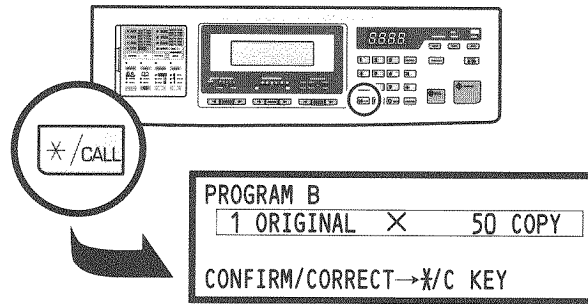

## 6 Enter other settings for Program B.

Specify the printing density, printing position, reproduction size, and so on. (The Two-Up feature can also be specified.)

**p.47, 48** .....Before pressing the START key, save the program in memory for quick recall if you use these programmed settings frequently.

## 7 Place an original face-down on the Stage Glass.

**NOTE** If the optional ADF Unit is installed, up to 50 programmed originals can be placed in the ADF Tray at one time.

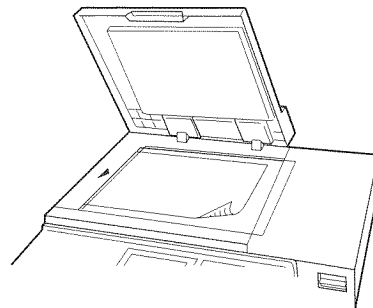

## 8 Press the START key.

Prints are produced according to the specified program, starting with the last original specified. When printing is completed for the current original, place the next original on the Stage Glass and press the START key again.

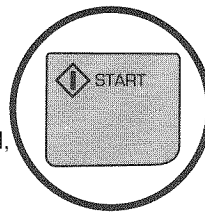

**NOTE** If the optional ADF Unit is used, this procedure is not required.

When printing is completed for all originals, the current Program B settings are automatically cleared.

To interrupt this programmed printing, press the STOP key.

Holding down the R •  $\frac{3}{4}$  (ALL RESET) key longer than one second returns the control panel to the initial settings and clears the program.

# Storing Settings in Memory

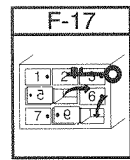







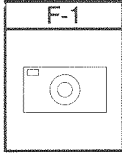
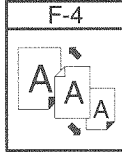
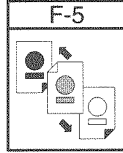
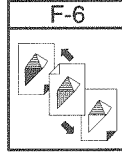
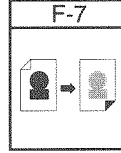

The Memory feature is a flexible tool for automating frequently used or complicated combinations of settings.

You can store up to 20 combinations of frequently used or complex print-job settings and apply them to new print jobs whenever necessary.





## SETTINGS and FEATURES ASSIGNABLE for MEMORY

Any combination of the following settings and features can be saved in memory for quick recall.

= Processing-related features =

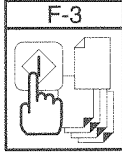
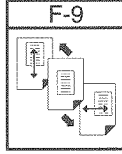
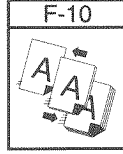
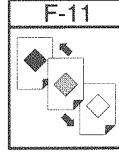
					
PHOTO	SIZE ADJUST	CONTRAST ADJUST	PHOTO CONTRAST	DOT PHOTO	BOUND ORIGINAL
 <b>p.24</b>	 <b>p.28</b>	 <b>p.30</b>	 <b>p.31</b>	 <b>p.31</b>	 <b>p.32</b>





= Printing-related features =

			
AUTO PRINT	PRINT POSITION	PRINT SPEED	PRINT DENSITY
 <b>p.26</b>	 <b>p.33</b>	 <b>p.34</b>	 <b>p.35</b>

= Print quantity setting =

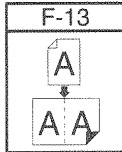
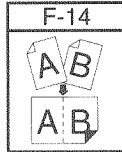
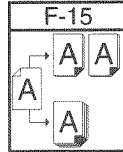
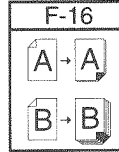

= Special features =

			
TWO-UP PRINT 1	TWO-UP PRINT 2	PROGRAM PRINT A	PROGRAM PRINT B
 <b>p.38</b>	 <b>p.39</b>	 <b>p.42</b>	 <b>p.44</b>

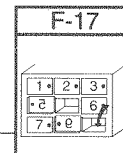

# Saving Settings

Once settings are saved in memory, the combination remains registered until the "C" key is used to remove it from memory.

**NOTE** It is recommended that you maintain a list of the Register Numbers currently in use and their associated settings.

## 1 Set up desired settings.

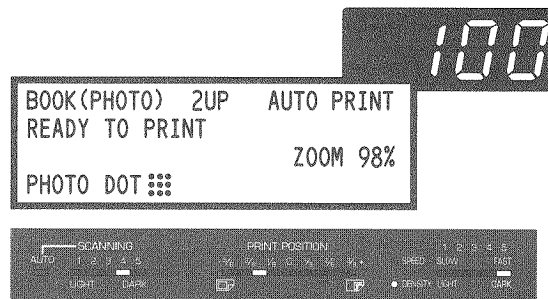

## 2 Press the MEMORY key to activate the Memory feature.

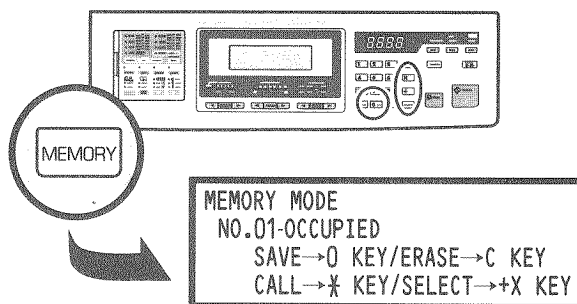

## 3 Select a vacant Register Number for the combination of settings entered.

Press the "+" or "X" key to find a vacant Register Number.

**NOTE** A message will appear in the Main Display informing you whether or not a Register Number is occupied.

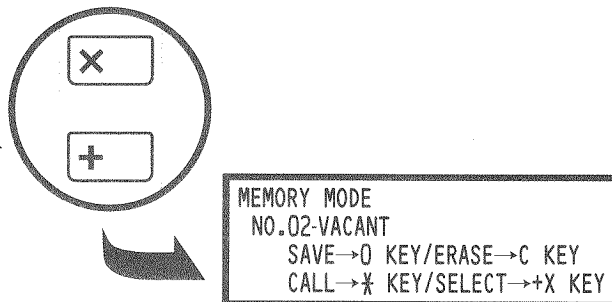

## 4 Press the SAVE key to save the settings to the selected Register Number.

A message will appear in the Main Display informing you that you have stored the setting. A long beep will sound and the memory feature is deactivated.

**NOTE** If you try to save the settings to an occupied Register Number, a beep will sound when you press the SAVE key. Press the "+" or "X" key to find a vacant Register Number or erase the current settings from the occupied Register Number and save the new settings.

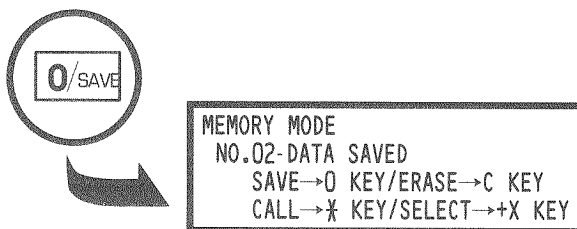

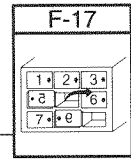

# Recalling Saved Settings

Use the CALL key to recall settings that are saved in memory.

**1 Press the MEMORY key to activate the Memory feature.**

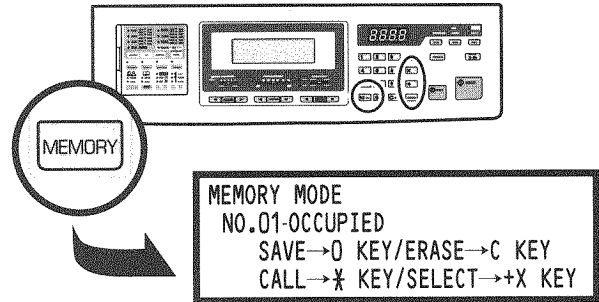

**2 Select the Register Number with the desired settings using the "+" or "X" key.**

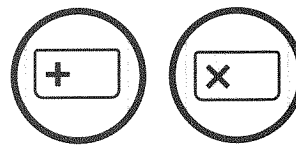

**NOTE** It is recommended that you maintain a list of the Register Numbers currently in use and their associated settings.

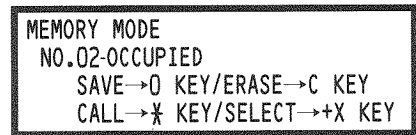

**3 Press the CALL key.**

The settings will be recalled from memory, and the indicators and displays on the control panel will light accordingly. A long beep sounds and the memory feature is deactivated.

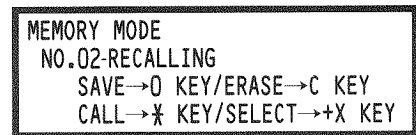
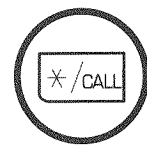

**NOTE** If you press the CALL key to recall settings from a vacant Register Number, a beep will sound and the following message will be shown. Press the "+" or "X" key to find an occupied Register Number.

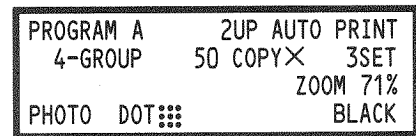

# Deleting Saved Settings

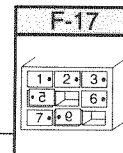

Use the "C" key to clear all settings from an occupied Register Number.

- 1 Press the MEMORY key to activate the Memory feature.**

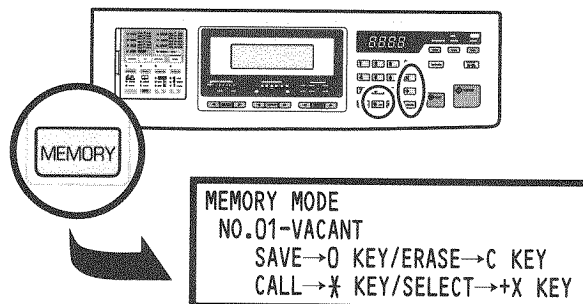

- 2 Use the "+" or "X" key to select the Register Number that you want to clear.**

**NOTE** It is recommended that you maintain a list of the Register Numbers currently in use and their associated settings.

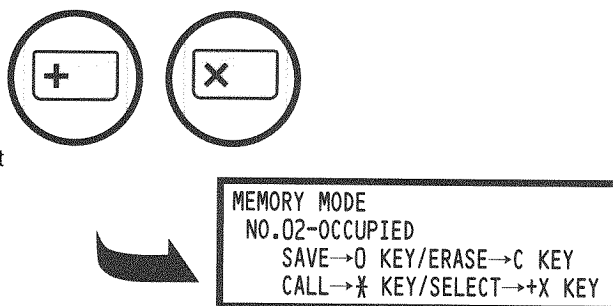

- 3 Press the "C" key.**

The settings are erased from the selected Register Number.

**NOTE** If you press the "C" key to clear a vacant Register Number, a beep will sound and the following message will be shown. Press the "+" or "X" key to find an occupied Register Number.

```
MEMORY MODE
NO.01-VACANT(NO DATA)
SAVE->0 KEY/ERASE->C KEY
CALL->* KEY/SELECT->+X KEY
```

As the memory feature remains active, you can make further memory settings or recall saved settings.

- 4 To deactivate the Memory feature, press the MEMORY key again.**

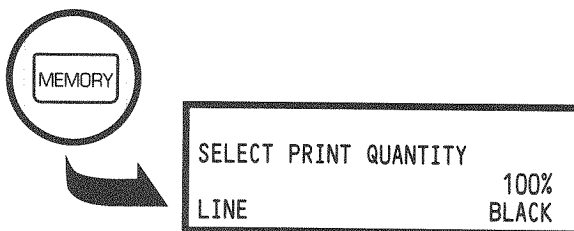

# Protecting Confidential Documents

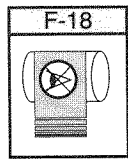

After printing is complete, the master remains on the Print Cylinder (Drum). Copies of this master can be printed at any time by pressing the START key. To protect confidential documents from unauthorized duplication, press the CONFIDENTIAL key to discard the master after printing.

## 1 Confirm that printing has ended.

## 2 Press the CONFIDENTIAL key.

The CONFIDENTIAL indicator lights and the following message appears in the Main Display.

**NOTE** To cancel the Confidential feature, press the STOP key or the CONFIDENTIAL key again.

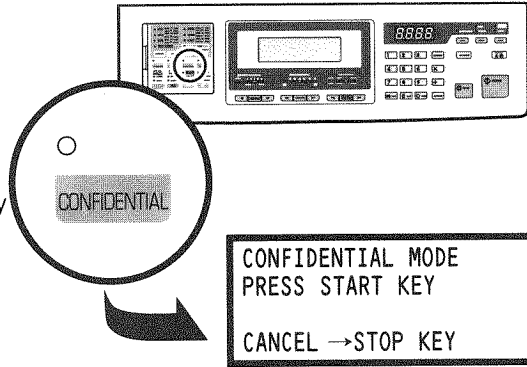

## 3 Press the START key.

The current master is discarded and replaced with a blank one. The CONFIDENTIAL indicator goes out, and the Confidential feature is canceled.

**NOTE** The master is discarded into the Master Disposal Box.

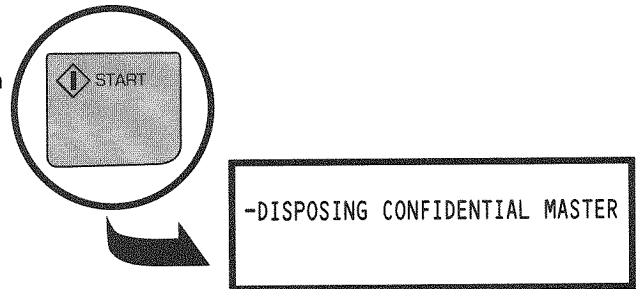

**p.62**.....For strictly confidential documents, discard the contents of the Master Disposal Box.



# Automatic Idle

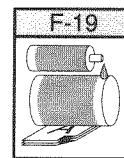

The Automatic Idle feature assures consistent print quality even after a long break by rotating the Print Cylinder (Drum) to ensure even ink distribution, and saves you from wasting paper due to faint images in printing.

**NOTE** When ordinary or test printing takes place after a long break, the Automatic Idle feature is ignored even when the Automatic Idle indicator is lit.

Whenever the Automatic Idle indicator is lit, the Automatic Idle feature is on. If you want to use this feature when the indicator is not lit, press the AUTO IDLE key to activate it.

This feature is automatically activated if the power is switched on when the machine unit has not been used for a certain period (6 to 12 hours).

**NOTE** You can select the minimum period required for the automatic activation of the Automatic Idle feature.

**p.52**.....You can customize initial settings.

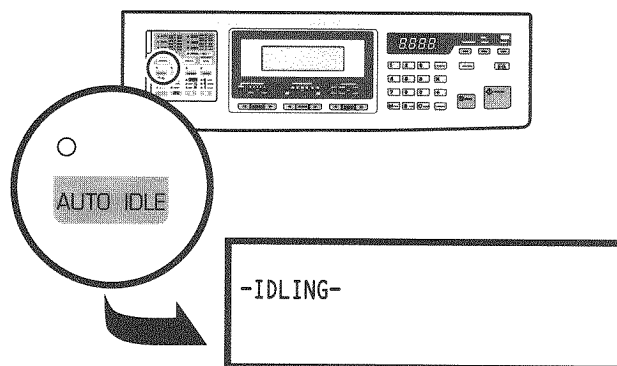

# Customizing the Initial Settings

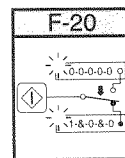

You can select some of the initial settings to which the machine status will be returned when the power is turned on, or the R •  (ALL RESET) key is held down for more than one second.

**NOTE** When you customize the initial settings, they remain valid until they are changed again.

## INITIAL SETTINGS OPEN TO ARBITRARY CHANGES

Item No.	Title	Description	Choices	Ref. Page
01	PRINT SPEED	Selects the initial print speed (copies per minute).	1(=60), 2(=80), <b>3(=100)</b> , 4(=110), 5(=120[cpm])	p.34
02	AUTO PRINT FEATURE	Selects the initial status of the Auto print feature.	<b>OFF</b> , ON	p.26
03	JUMP WING SETTING (EJECTION GUIDE ARRANGING)	Activates/Deactivates the Jump wings (Ejection guides) at paper exit.	<b>AUTO</b> , OFF	
04	DISPLAYED PRINT QUANTITY	Selects the initial number appearing in Print quantity display.	<b>0000</b> , 0001	
05	MASTER-MAKING AREA LIMIT	Selects the maximum image area for a master.	<b>VARIABLE</b> , 11×17(A3), 8.5×14(B4), 8.5×11(A4)	p.14
06	AUTO RESET TIME	Gives/Ignores the period for automatic initialization.	<b>NONE</b> , 5 Minutes	p.36
07	MINIMUM PRINT QUANTITY	Selects the minimum print quantity which should be produced from one master.	<b>1</b> , 10, 20, 30 [copies]	
08	AUTO IDLE PERIOD	Selects the period required for automatic activation of the Auto-idle feature.	<b>12 Hours</b> , 6 Hours, OFF (No limit)	p.51
09	AUTO DOCUMENT FEED	Requires the START key or Not, to feed the following original placed in the optional ADF unit without the Auto print feature activated.	<b>OFF</b> (START key required), ON (START key not required)	
10	IMAGE PROCESSING	Selects the initial image processing mode.	<b>LINE</b> , DUO	p.24
11	TWO-UP TIME INTERVAL (TWO-UP ON-STAGE INTERVAL)	Gives/Ignores the interval required for replacing the original placed on the Stage glass for Two-up printing.	<b>NONE (No interval)</b> , 15 Seconds	p.39
13	JOB SEPARATOR CONNECTION	Opens/Closes the data line for the optional Job Separator. Select "YES" when attaching the Job Separator.	<b>NO (Close data line)</b> , YES (Open data line)	p.78
17	DISPLAYED LANGUAGE	Selects a displayed language.	Consult your service representative.	

\* The framed item is the default setting.

**1 Press "8" while holding down the CALL key.**

Access the changeable initial settings.

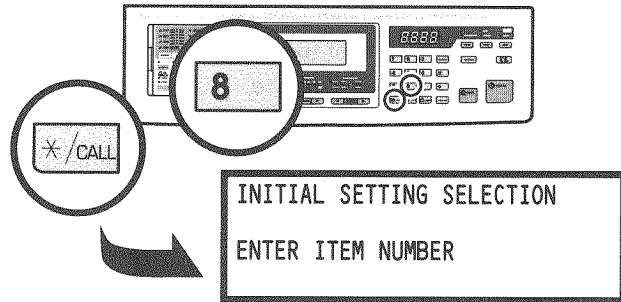

**2 Enter the item number that you want to customize.**

Use the Print Quantity keys.

**NOTE** For item numbers under 10, press "0" first.

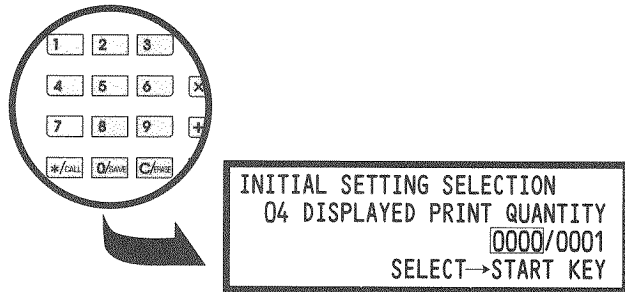

**3 Press the START key.**

Each time you press the START key, the setting is changed. Select a desired setting.

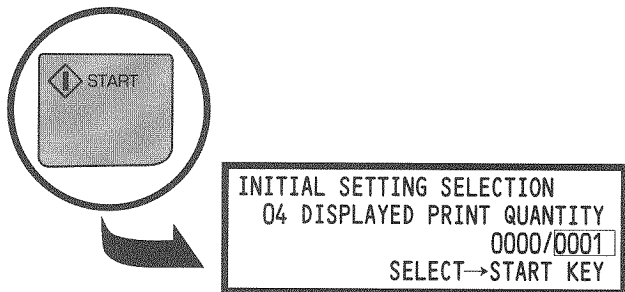

**4 Press the R • %v (ALL RESET) key.**

After customizing the settings, hold down the ALL RESET key for more than one second. The custom settings appear as the initial settings when the power is turned ON or the ALL RESET key is held down for more than one second.

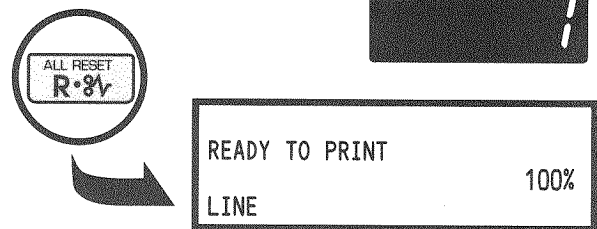

# Changing Print Color

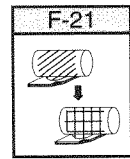

To print with an optional color Cylinder (Drum), simply remove the existing Cylinder (Drum) from your Risograph and replace with the color of choice.

When a Print Cylinder (Drum) other than the Black one is in place, the "COLOR" message appears in the Main Display



**⚠ Caution** Only use Risograph GR Print Cylinder (Drum).

- NOTE**
- Change Print Cylinder (Drum) with the power ON.
  - Store the removed Print Cylinder (Drum) horizontally in the Print Cylinder (Drum) case.
  - Never store Print Cylinder (Drum) in an upright position.

54

## Changing Print Cylinders (Drums)

**1** Open the Front Cover.

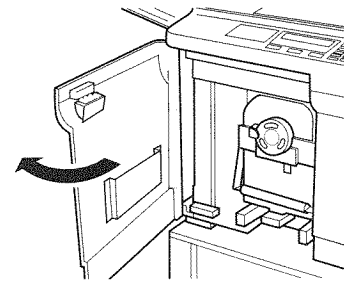

**2** Be sure that the Print Cylinder (Drum) Home Position button/indicator is lit.

If not lit, press the Print Cylinder (Drum) Home Position button/indicator. The Print Cylinder (Drum) will rotate and stop at the preset home position, making the indicator light.

**NOTE** If the Print Cylinder (Drum) Home Position button/indicator is not lit, the Print Cylinder (Drum) cannot be pulled out.

**3** Pull out the Print Cylinder (Drum).

Raise the Print Cylinder (Drum) Handle until it is level and pull out the Print Cylinder (Drum) until it stops.

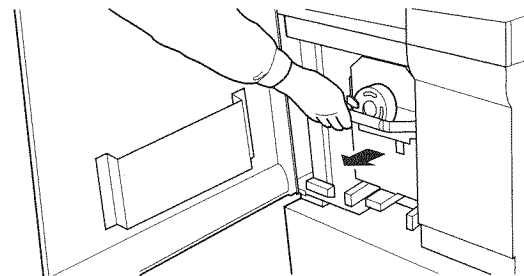
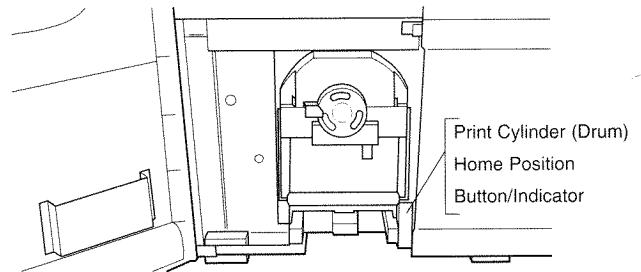

**4 Remove the Print Cylinder (Drum) from the unit.**

Lift the Print Cylinder (Drum) with both hands to remove it.

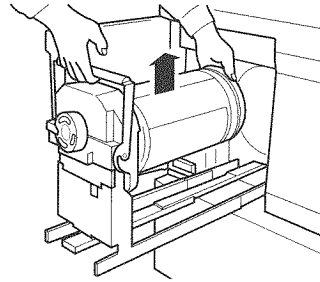

**5 Load another color Print Cylinder (Drum) onto the holder.**

Insert another Print Cylinder (Drum) into the holder horizontally, holding the handle and body with both hands.

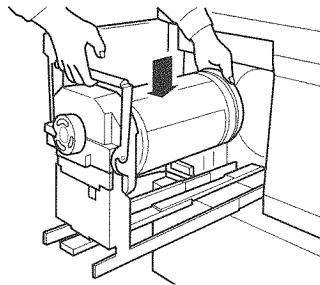

**6 Slide the Print Cylinder (Drum) into the unit.**

With the Print Cylinder (Drum) Handle in its raised position, slide the Print Cylinder (Drum) into the unit until it stops. Then lower the handle and close the Front Cover.

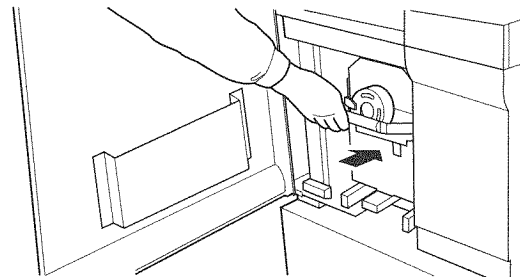

**⚠ Caution** The Print Cylinder (Drum) contains highly sensitive electronic components. To avoid damage by an electrostatic charge, do not touch the Print Cylinder (Drum) Connector.

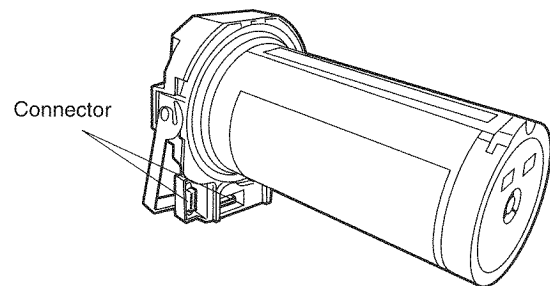

# Interfacing with a Computer

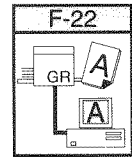

Your Risograph can be interfaced with computers (such as IBM and compatibles, and Macintosh) via the dedicated computer interface (optional).

When the Risograph is interfaced with a computer, the I/F key opens the interface line to the computer.

For more details on how to interface with computers, consult the manual for the Risograph Computer Interface system.

## 1 Open the sub-panel cover and press the I/F key.

The "INTERFACE MODE" message appears in the Main Display when the interface line to a computer is open.

**NOTE** The following features become inactive when the I/F key is selected:

- SIZE ADJUSTMENT FEATURE -

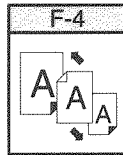

- TWO-UP PRINTING FEATURE -

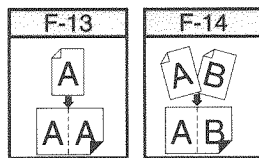

- PROGRAMMED PRINTING FEATURE -

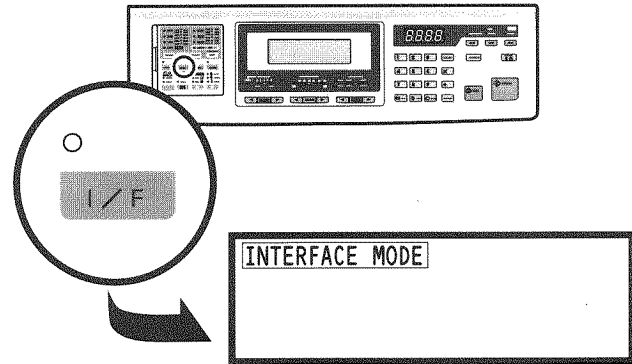
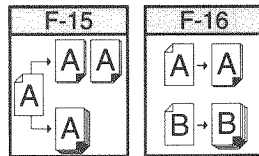

# Replenishing and Disposing Supplies

This section describes how to replenish supplies and dispose of them regularly.

- Replacing the Ink Cartridge .....58
- Replacing the Master Roll .....60
- Emptying the Master Disposal Box .....62

# Replacing the Ink Cartridge

- 1** Open the Front Cover, and pull the empty Ink Cartridge out of the Print Cylinder (Drum).

Release the Ink Cartridge Locking Lever (green in color) and pull the empty Ink Cartridge out of the Print Cylinder (Drum).

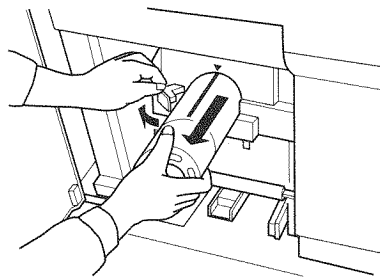

- 2** Remove the cap from a new Ink Cartridge.

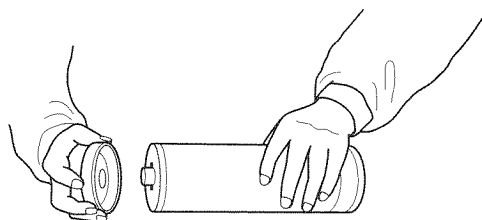

- 3** Align the arrow on the new Ink Cartridge with the arrow marked on the Print Cylinder (Drum).

While holding the Ink Cartridge Locking Lever aside, rotate the Ink Cartridge until its arrow meets the arrow marked on the Print Cylinder (Drum).

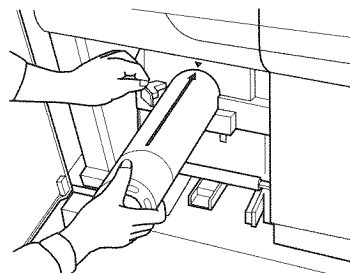

- 4** Insert the new Ink Cartridge all the way into the Print Cylinder (Drum).

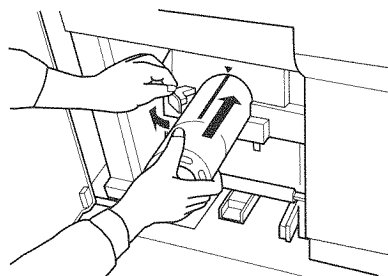



**5 Lock the Ink Cartridge into place, and close the Front Cover.**

Return the Ink Cartridge Locking Lever to its initial position to keep the Ink Cartridge in place. Also, press on the lower right-hand area of the Front Cover to close it securely.

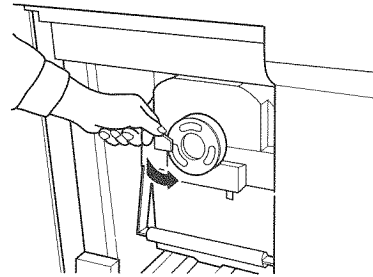

**Important!**

- **Never insert a cartridge of a different color ink.**

Always be sure that the color of the new Ink Cartridge is the same as that of the old one being replaced. If you want to change the print color, you must replace the entire Print Cylinder (Drum).

- **There is ink on the master wrapped around the Print Cylinder (Drum). Keep your hands and clothing away from it.** If your hands come into contact with ink, wash thoroughly.

# Replacing the Master Roll

## 1 Raise the Scanner Table.

Hold the Scanner Table Release Lever and raise the Scanner Table until it stops.

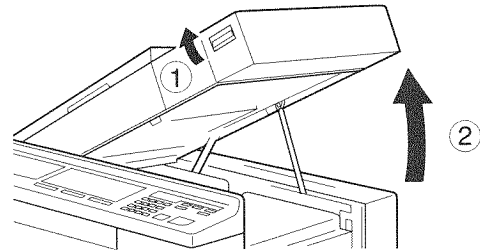

## 2 Open the Master Loading Unit.

Open the Master Loading Unit by pulling down the green Master Loading Unit Release Lever, which is located on the right side of the unit.

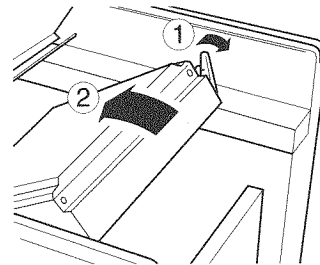

## 3 Open the Master Roll Cover.

Pull the Master Roll Cover down.

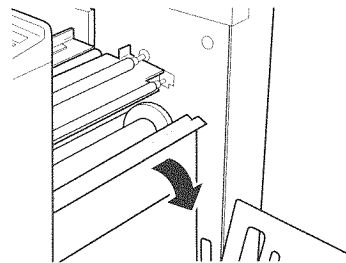

## 4 Remove the depleted Master Roll.

Pushing the depleted Master Roll to the right, pull it toward you and remove it from the supporter.

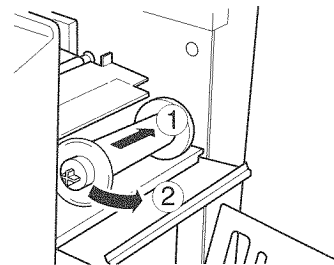

## 5 Remove both left and right flanges.

Remove both left and right flanges from the depleted Master Roll.

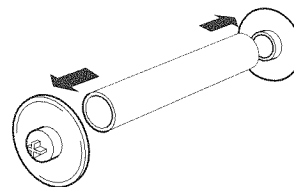

**6 Attach the existing flanges to a new Master Roll.**

Unpack a new Master Roll.

Attach the flanges removed from the depleted Master Roll to the new one, with the colored flange to the right end and the white one to the left end. Then unwrap the new Master Roll.

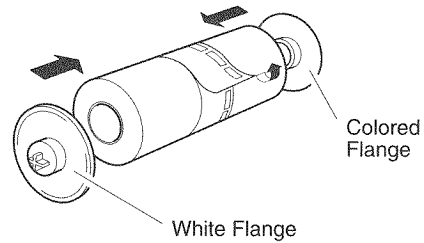

**7 Install the new Master Roll.**

Pushing the colored flange onto the right-hand flange holder, slide the white flange securely into the center groove of the supporter.

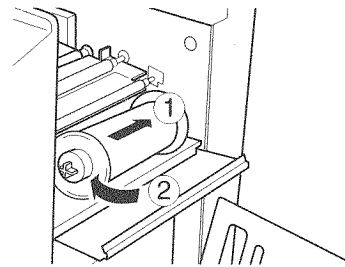

**8 Insert the leading edge of the Master Roll under the green films.**

Unroll the Master Roll by pulling on the leading edge and insert the leading edge under the green films.

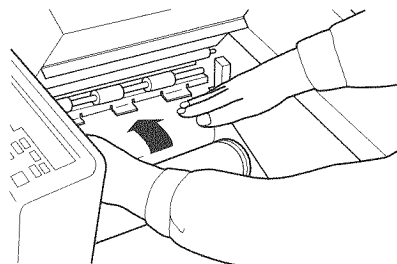

**9 Close the Master Roll Cover.**

Close the Master Roll Cover gently.

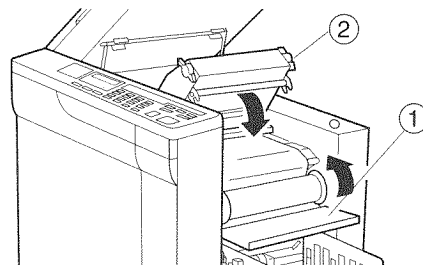

**10 Close the Master Loading Unit and the Scanner Table.**

Close the Master Loading Unit gently and return the Scanner Table to the original position.

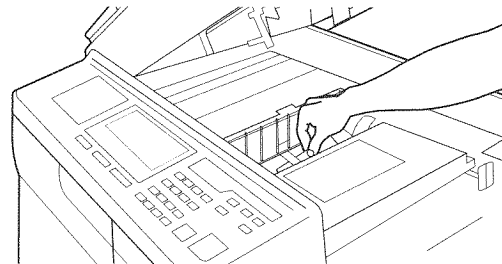

**Important!**

If the leading edge of the Master Roll is inserted too far beyond the green films, the excess portion will be automatically cut off. If the strip that has been cut off remains inside, an advisory message will appear in the Main Display to advise you to remove it. Be sure to remove the cut-off strip.

# Emptying the Master Disposal Box

## 1 Pull out the Master Disposal Box.

Squeeze both the upper and lower handles of the Master Disposal Box together and pull out.

**NOTE** When carrying the Master Disposal Box, be sure to hold the handles so as not to drop used masters.

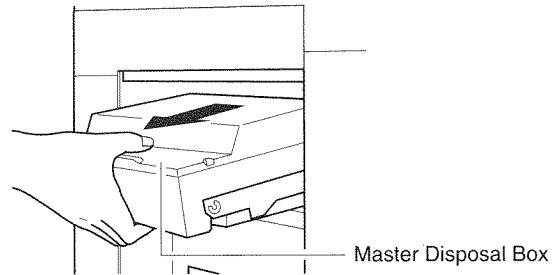

## 2 Discard used masters.

While holding the handles, open the cover by pulling the locking lever up, then discard used masters. Return the locking lever and close the cover.

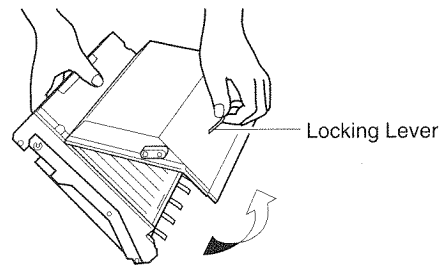

## 3 Insert the Master Disposal Box into position.

Holding the handles, insert the Master Disposal Box into position as far as it will go. Then release the handles.

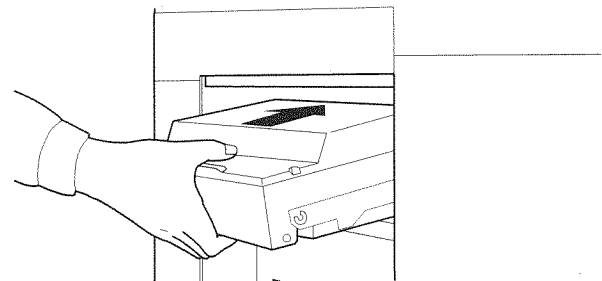





# Advisory Messages

This section describes how to respond to advisory messages in the Main Display. If you need help in following a message's direction, consult the alphabetized index chart below and refer to the corresponding page.



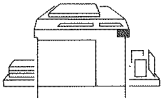

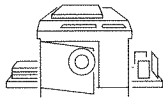
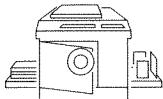
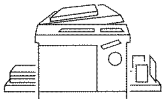
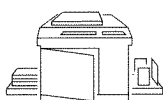
## Index

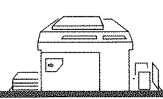
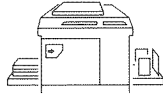
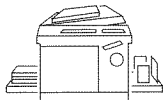
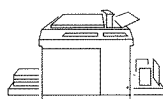
<b>ADD</b>		<b>ORIGINAL</b>	
ADD PAPER .....	66	ORIGINAL JAM.....	68
<b>CHECK</b>		ORIGINAL MISFEED .....	68
CHECK PAPER FEED AREA .....	68	<b>PAPER</b>	
<b>CLAMP</b>		PAPER JAM CHECK PAPER.....	67
CLAMP ERROR.....	66	PAPER JAM IN SORTER.....	68
<b>CLOSE</b>		PAPER JAM ON PRINT CYLINDER (DRUM) .....	68
CLOSE ADF COVER.....	64	PAPER JAM REMOVE PAPER.....	67
CLOSE FRONT COVER.....	64	PAPER JAM UNDER DRUM.....	67
CLOSE MASTER LOADING UNIT .....	64	PAPER MISFEED .....	68
CLOSE SCANNER TABLE.....	64	<b>REMOVE</b>	
CLOSE SHEET FEEDER COVER .....	65	REMOVE CUT MASTER STRIP .....	67
CLOSE SORTER'S COVER .....	65	REMOVE JAMMED MASTER IN DISPOSAL UNIT.....	67
<b>DISPOSAL</b>		<b>REPLACE</b>	
DISPOSAL ERROR .....	67	REPLACE INK CARTRIDGE .....	66
<b>EMPTY</b>		REPLACE MASTER ROLL.....	66
EMPTY DISPOSAL BOX .....	66	<b>SET</b>	
<b>INSERT</b>		SET DRUM IN PLACE.....	64
INSERT CARD IN KEY/CARD COUNTER.....	64	SET LEAD EDGE OF MASTER UNDER GREEN FILM .....	64
<b>INSTALL</b>		SET MASTER DISPOSAL BOX .....	64
INSTALL INK CARTRIDGE .....	64	<b>T##</b>	
INSTALL MASTER DISPOSAL BOX.....	64	T##: CALL SERVICE .....	65
INSTALL PRINT CYLINDER.....	64	T##: TURN MAIN POWER SW. OFF THEN ON.....	65
<b>MASTER</b>		<b>WRONG</b>	
MASTER CUT ERROR.....	66	WRONG-SIZE PRINT CYLINDER (DRUM) INSTALLED .....	65
MASTER MIS-FEED .....	66	WRONG-TYPE INK CARTRIDGE .....	65
<b>NO MASTER</b>		WRONG-TYPE PRINT CYLINDER (DRUM) INSTALLED .....	65
NO MASTER ON PRINT CYLINDER (DRUM) .....	67		

# Requesting Proper Setting

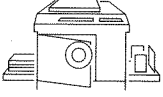
Message	Description and Action	Reference
 <p>INSERT CARD IN KEY/CARD COUNTER</p>	<p>An operator card is required to be inserted into the Key/card counter (optional).</p> <p><b>Action</b> Insert it.</p>	<p><b>p.78</b></p>
 <p>SET DRUM IN PLACE</p>  <p>INSTALL PRINT CYLINDER</p>	<p>The Print Cylinder (Drum) is not properly installed.</p> <p><b>Action</b> Slide it into place, holding the handle.</p>	<p><b>p.54</b></p>
 <p>INSTALL INK CARTRIDGE</p>	<p>An Ink cartridge is not properly installed.</p> <p><b>Action</b> Insert it completely and hook the locking lever on it.</p>	<p><b>p.58</b></p>
 <p>SET LEAD EDGE OF MASTER UNDER GREEN FILM</p>	<p>Master is not properly loaded.</p> <p><b>Action</b> Install a Master roll, if required, and insert the lead edge under the green plastic film tabs.</p>	<p><b>p.60</b></p>
 <p>CLOSE FRONT COVER</p>	<p>The Front cover is not properly closed.</p> <p><b>Action</b> Close it tightly, pressing on the lower right-hand area.</p>	
 <p>CLOSE SCANNER TABLE</p>	<p>The Scanner table is not properly closed.</p> <p><b>Action</b> Close it tightly, holding it down.</p>	
 <p>SET MASTER DISPOSAL BOX IN PLACE</p>  <p>INSTALL MASTER DISPOSAL BOX</p>	<p>The Master disposal box is not properly loaded.</p> <p><b>Action</b> Insert it completely, holding the handles.</p>	<p><b>p.62</b></p>
 <p>CLOSE MASTER LOADING UNIT</p>	<p>The Master loading unit is open.</p> <p><b>Action</b> Open the Scanner table and close the Master loading unit securely.</p>	
 <p>CLOSE ADF COVER</p>	<p>The ADF (optional) cover is not properly closed.</p> <p><b>Action</b> Close it tightly.</p>	

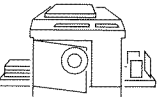
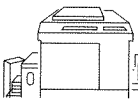

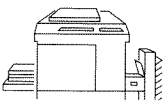
# Requesting Proper Setting

Message	Description and Action	Reference
 <p>WRONG-SIZE DRUM INSTALLED</p>  <p>WRONG-SIZE PRINT CYLINDER INSTALLED</p>	<p>This size Print Cylinder (Drum) is not acceptable for this machine.</p> <p><b>Action</b> Install a correct size one. If you don't know what Print Cylinder (Drum) is of the correct size, contact your service representative.</p>	<b>p.54</b>
 <p>WRONG-TYPE DRUM INSTALLED</p>  <p>WRONG-TYPE PRINT CYLINDER INSTALLED</p>	<p>This type of Print Cylinder (Drum) is not acceptable for this machine.</p> <p><b>Action</b> Install a correct type. If you don't know what Print Cylinder (Drum) is the correct type, contact your service representative.</p>	<b>p.54</b>
 <p>WRONG-TYPE INK CARTRIDGE INSTALLED</p>	<p>This type of ink cartridge is not acceptable for this machine.</p> <p><b>Action</b> Insert a correct type. If you don't know what Ink cartridge is the correct type, contact your service representative.</p>	<b>p.58</b>
 <p>CLOSE SHEET FEEDER COVER AND PRESS ALL RESET KEY</p>	<p>The cover of the sheet feeder SF3000 (optional) is not properly closed.</p> <p><b>Action</b> Close it tightly and press the R• (ALL RESET) key.</p>	<b>p.78</b>
 <p>CLOSE SORTER'S COVER</p>	<p>The cover of the sorter (optional) is not properly closed.</p> <p><b>Action</b> Close it securely.</p>	<b>p.78</b>

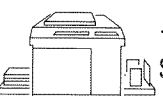
# Requesting Technical Support

Message	Description and Action	Reference
 <p>T## CALL SERVICE</p>	<p><b>Action</b> Contact your authorized service representative and report him or her the trouble code (T##).</p>	
 <p>T## TURN MAIN POWER SW. OFF THEN ON</p>	<p><b>Action</b> Turn the power off and then on again. If this message still appears, contact your authorized service representative and report him or her the trouble code (T##).</p>	

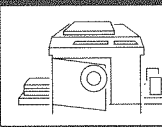
# Requesting Supply and Disposal

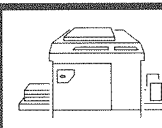
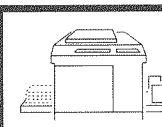
Message	Description and Action	Reference
 <p>REPLACE INK CARTRIDGE</p>	<p>An Ink cartridge is empty. <b>Action</b> Replace it with a new one.</p>	p.58
 <p>REPLACE MASTER ROLL</p>	<p>A Master roll is depleted. <b>Action</b> Install a new one.</p>	p.60
 <p>EMPTY DISPOSAL BOX</p>	<p>The Master disposal box is full of used masters. <b>Action</b> Pull out the box and discard used masters.</p>	p.62
 <p>ADD PAPER</p>	<p>Paper is depleted and/or not loaded in the Paper feed tray. <b>Action</b> Load paper in the Paper feed tray.</p>	p.16

# Informing Troubles in Master-Making Area

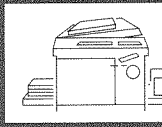
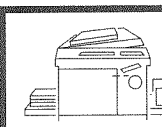
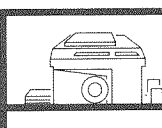
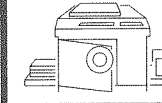
Message	Description and Action	Reference
 <p>CLAMP ERROR REMOVE MASTER ROLL THEN RE- INSTALL</p>	<p>Master has not been properly loaded on the Print Cylinder (Drum). <b>Action</b> Open the Master loading unit and wind the Master roll. Reload master. After closing the Master loading unit, press the START key to restart the master-making operation.</p>	p.60
 <p>MASTER MIS-FEED REMOVE MASTER ROLL THEN RE- INSTALL</p>	<p>Master has misfed. <b>Action</b> Open the Master loading unit and wind the Master roll. Reload master.</p>	p.60
 <p>MASTER CUT ERROR REMOVE DRUM AND CHECK MASTER</p>	<p>Master was not cut correctly. <b>Action</b> Open the Front cover and pull out the Print Cylinder (Drum) to check whether a master was properly loaded. If not, remove the master and restart the operation from master-making.</p>	p.54
 <p>MASTER CUT ERROR REMOVE PRINT CYLINDER AND CHECK MASTER</p>		





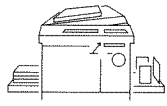
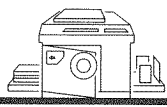
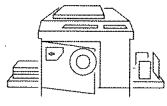
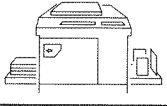



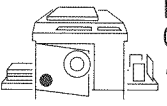
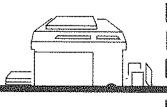
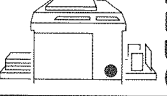

# Informing Troubles in Master-Making Area

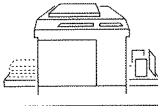
Message	Description and Action	Reference
 <p>REMOVE CUT MASTER STRIP</p>	<p>A cut-off piece of master has been left inside the Master loading unit.</p> <p><b>Action</b> Open the Scanner table and Master loading unit and remove the piece.</p>	p.61
 <p>DISPOSAL ERROR REMOVE DRUM AND DISCARD MASTER</p>	<p>A used master remains on the Print Cylinder (Drum).</p> <p><b>Action</b> Open the Front cover, pull out the Print Cylinder (Drum) and remove the remaining master.</p> <p>After returning the Print Cylinder (Drum) to its position, press the START key to restart the master-making operation.</p>	p.54
 <p>DISPOSAL ERROR REMOVE PRINT CYLINDER AND DISCARD MASTER</p>		
 <p>REMOVE JAMMED MASTER IN DISPOSAL UNIT</p>	<p>A used master is stuck at the entrance of the Master disposal box.</p> <p><b>Action</b> Pull out the Master disposal box and look inside. If a master is present, remove it.</p>	p.62

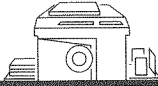
# Informing Troubles in Printing Area

Message	Description and Action	Reference
<p>NO MASTER ON DRUM PRESS ALL RESET KEY AND MAKE A NEW MASTER</p>	<p>There is no master on the Print Cylinder (Drum).</p> <p><b>Action</b> Press the R • ⌘ (ALL RESET) key to clear the message from the display. Then place an original on the Stage glass or in the ADF tray and press the START key.</p>	
<p>NO MASTER ON PRINT CYLINDER PRESS ALL RESET KEY AND MAKE A NEW MASTER</p>		
 <p>PAPER JAM CHECK PAPER FEED AREA</p>	<p>Paper is jammed in the paper feed area.</p> <p><b>Action</b> Open the Front cover, pull out the Print Cylinder (Drum) and remove the paper.</p>	p.54
 <p>PAPER JAM UNDER DRUM PULL OUT DRUM</p>	<p>Paper is jammed under the Print Cylinder (Drum) or in the paper ejection area.</p> <p><b>Action</b> Open the Front cover, pull out the Print Cylinder (Drum) and remove the paper.</p>	p.54
 <p>PAPER JAM REMOVE PAPER UNDER PRINT CYLINDER</p>		

# Informing Troubles in Printing Area

Message	Description and Action	Reference
 <p>PAPER MISFEED CHECK PAPER FEED AREA AND PRESS ALL RESET KEY</p>	<p>Paper was not fed or was improperly fed. <b>Action</b> Check paper and the Paper feed tray and press the R •  (ALL RESET) key.</p>	p.16
 <p>PAPER JAM ON DRUM REMOVE PAPER</p>	<p>Paper has stuck to the Print Cylinder (Drum). <b>Action</b> Open the Front cover, pull out the Print Cylinder (Drum) and remove the paper.</p>	p.54
 <p>PAPER JAM ON PRINT CYLINDER REMOVE PAPER</p>		
 <p>PAPER JAM IN SORTER REMOVE PAPER</p>	<p>Paper is jammed in the sorter (optional). <b>Action</b> Open the cover of the sorter and remove the paper.</p>	
 <p>CHECK PAPER FEED AREA</p>	<p>The safety switch above or under the Paper feed tray has been activated. <b>Action</b> Check the paper feed area for any obstructions and clear it if an obstacle is found.</p>	p.16
<p><b>NOTE TO PREVENT PAPER JAMS</b></p> <ul style="list-style-type: none"> <li>Use flat printing paper that is free of folds. If curled paper is unavoidable, place it so that the curl faces down.  p.14</li> <li>When using smooth paper for printing, set the Paper feed pressure adjustment lever to "CARD".  p.16</li> </ul>		

# Informing Troubles in Optional ADF Unit

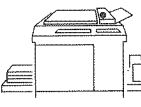
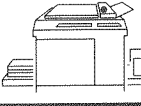
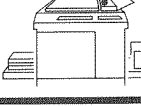
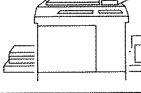
Message	Description and Action	Reference
 <p>ORIGINAL MISFEED OPEN ADF COVER AND RESET ORIGINAL</p>	<p>An original was not fed, or was improperly fed. <b>Action</b> Open the ADF cover by holding the ADF cover release lever. Then remove the original and reset it.</p>	p.76
 <p>ORIGINAL JAM RESET ORIGINAL</p> <p>/1</p>	<p>An original is jammed at the entrance of the ADF unit. <b>Action</b> Open the ADF cover by holding the ADF cover release lever. Then remove the original and reset.</p>	p.76
 <p>ORIGINAL JAM REMOVE ORIGINAL</p> <p>/2</p>	<p>An original is too long for the ADF unit. <b>Action</b> Open the ADF cover by holding the ADF cover release lever. Then remove the original and place it on the Stage glass.</p>	p.76
 <p>ORIGINAL JAM RESET ORIGINAL</p> <p>/3</p>	<p>An original is jammed at the exit of the ADF unit. <b>Action</b> Open the ADF cover by holding the ADF cover release lever. Then remove the original and reset.</p>	p.76

# Troubleshooting Tips

This section describes how to take care of problems that may arise with your Risograph.

Check the following "Tips List" and the related items before calling your authorized service representative.

## Tips List

- The unit does not start even when the power switch is pressed.....70
- The "CLOSE FRONT COVER" message appears even when the Front cover is closed.....70
- There is no image on copies.....70
- The unwanted background of an original is picked up on copies.....70
- Copies are incomplete; some images are missing or unclear.....70
- Printed images are excessively faint or blurred.....71
- Vertical blank lines are found on printed copies.....71
- The back of finished copies are smudged with ink.....71
- Paper sticks to the surface of the Print Cylinder (Drum).....71
- Paper slips when it is fed.....71

**The unit does not start even when the power switch is pressed.**

- **Action** • Check whether the power cord is firmly connected to an electrical outlet.
- Check whether the power cord is connected to the unit.
- Check whether the commercial power circuit breaker is on.

**The "CLOSE FRONT COVER" message appears even when the Front cover is closed.**

- There is a metal plate in the lower right-hand section of the Front cover. Unless this plate is in direct contact with the magnet on the lower right-hand part of the machine, the advisory message remains on the Main Display.
- **Action** Press on the lower right-hand area of the Front cover to close it tightly.

**There is no image on copies.**

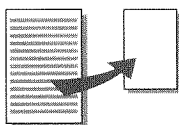

- Check whether the original is correctly placed.
- **Action** Be sure it is placed face down.  
☞ p.22
- Check whether the master is correctly placed.
- **Action** Be sure that it is placed with the leading edge unrolled from below.  
☞ p.61

**The unwanted background of an original is picked up on copies.**



- If newspaper or colored paper is used as an original, the background might have been picked up on copies.
- **Action** Press the SCANNING CONTRAST Adjustment key (<J>) to make the scanning contrast lighter. Then replace the original and press the START key.  
☞ p.30

**Copies are incomplete; some images are missing or unclear.**



- The Stage glass may be stained with correction fluid or glue.
- **Action** Open the Stage cover and clean the Stage glass using a soft cloth or tissue.  
☞ p.75
- A foreign object may be on or under the master on the Print Cylinder (Drum).
- **Action** Pull out the Print Cylinder (Drum) and remove the object.  
☞ p.54
- The Stage glass was open during scanning.
- **Action** Images were not scanned properly because of exposure to light. Be sure that the Stage cover is closed during scanning.
- Verify that the current Bound Original setting is appropriate for the original.
- **Action** If the original has no margins around the edges, cancel the Bound Original feature.  
☞ p.32

**Printed images are excessively faint or blurred.**

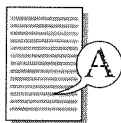

- If the machine is not used for a long period of time, ink on the surface of the Print Cylinder (Drum) may dry. Dry ink on the Print Cylinder (Drum) may cause faint or blurred printing.
  - Action** Press the TEST PRINT key several times until a clear printed image is obtained.
    - ☞ p.25
  - Action** Activate the Automatic Idle feature before operation to prevent light images that may occur after periods of non-use.
    - ☞ p.51
- Light originals result in light images.
  - Action** Press the SCANNING CONTRAST Adjustment key (▷) to make scanning contrast darker. Then replace the original and press the START key.
    - ☞ p.30
- If the temperature is low (below 59°F or 15°C) or the Ink cartridges are stored in a cold place, ink may not flow smoothly.
  - Action** Warm the room or Ink cartridge before operating the unit.

**Vertical blank lines are found on printed copies.**



- The Thermal print head (the device that makes the master) may be smudged with paper powder from the master.
  - Action** Open the Master loading unit and clean the Thermal print head using a soft cloth or tissue.
    - ☞ p.75
- The Stage glass may be stained with correction fluid or dust.
  - Action** Open the Stage cover and gently clean the Stage glass using a soft cloth or tissue.
    - ☞ p.75

**If the optional ADF unit is installed:**

- The ADF scanner glass may be smudged with dust or correction fluid.
  - Action** Open the ADF cover and clean the glass using a soft cloth or tissue.
    - ☞ p.76

**The back of finished copies are smudged with ink.**



- The rubber Pressure roller, which keeps printing paper pressed against the Print Cylinder (Drum) during printing, may be stained with ink.
  - Action** Remove the Print Cylinder (Drum) and clean the roller gently with a soft cloth or tissue.
    - ☞ p.75
- The Feed tray paper guides are set at maximum width.
  - Action** Adjust the Feed tray paper guides to fit the width of the printing paper.
    - ☞ p.16

**Paper sticks to the surface of the Print Cylinder (Drum).**

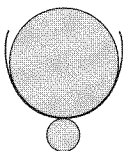

- Action**
  - Use recommended printing paper.
    - ☞ p.14
  - Lower the vertical print position with the PRINT POSITION Adjustment key ◀.
    - ☞ p.33
  - Replace the original in the reverse direction and restart printing from the beginning (master-making).

**Paper slips when it is fed.**

- Misfeeding of printing paper might have caused a paper jam.
  - Action** Set the Paper feed pressure adjustment lever to "CARD."
    - ☞ p.16



# Maintenance

This section describes the actions to be taken to maintain your machine in proper working order.

- **Cautions Concerning Maintenance.....74**
  - Replacing the Lithium Battery .....74
- **Cleaning : Preventing Defective Prints.....75**
  - Cleaning the Thermal Print Head.....75
  - Cleaning the Stage Glass and Stage Cover .....75
  - Cleaning the Pressure Roller .....75
  - Cleaning the Risograph Exterior .....76
  - Cleaning the Optional ADF Scanner Glass.....76
  - Cleaning the White Roller.....76

# Cautions Concerning Maintenance

## **⚠ WARNING [ To Avoid Personal Injury During Handling ]**

- DO NOT allow unauthorized persons to make adjustments or repairs.
- DO NOT remove any fixed covers.
- CALL your dealer immediately if you suspect any dangerous situations or have questions or problems with the unit.
- Precision parts and driving mechanisms are contained in the unit. Do not perform actions other than those described in this manual.
- Don't make any modifications to the unit or remove parts.
- When you want to move the unit, contact your dealer.

## **⚠ Caution [ To Avoid Mechanical Problems ]**

- The best safety device is an alert person who demonstrates good sense.
- Neither RISO nor its dealer is responsible for maintenance service performed by non-RISO-authorized personnel.

74

## Replacing the Lithium Battery

The lithium battery in your machine should last about five years.

When the battery is losing power, the message to the right appears in the Main Display:



**⚠ Caution** The lithium battery must be replaced by a trained and authorized service technician.



# Cleaning : Preventing Defective Prints

## Cleaning the Thermal Print Head

Clean the Thermal Print Head after every two Master rolls. Lift up the Scanner table and open the Master loading unit. Then gently wipe the Thermal Print Head (inside the unit) several times with a soft cloth or tissue.

**NOTE** For more effective cleaning, dampen a soft cloth or tissue with a small amount of alcohol before wiping the Thermal Print Head.

**Caution** Since the Thermal Print Head is very delicate, avoid shocks or scratching with a hard object.

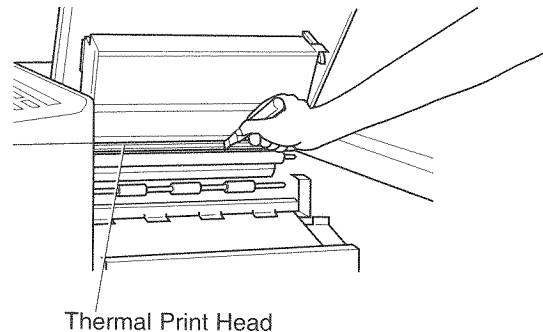

## Cleaning the Stage Glass and Stage Cover

If the Stage Glass and/or Stage Cover is stained, imperfections may appear on prints.

Wipe them gently with a soft cloth or tissue.

**Caution** Since the Stage Glass is very delicate, avoid shocks or scratching with a hard object.

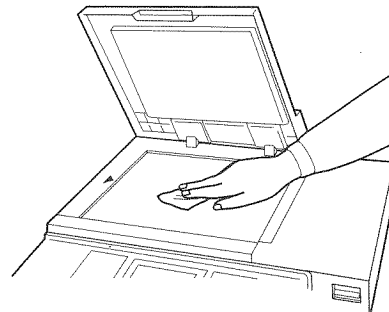

## Cleaning the Pressure Roller

If the rubber Pressure Roller [that presses printing paper against the Print Cylinder (Drum)] is stained, smudged strips may appear on the back sides of copies.

In such a case, wipe the Pressure Roller thoroughly with a soft cloth dampened with alcohol, or pass used paper with a blank master loaded on the Print Cylinder (Drum) using the Confidential feature.

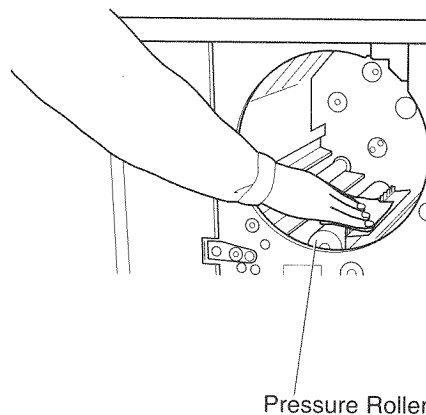

## Cleaning the Risograph Exterior

To remove dust, wipe the machine exterior periodically with a soft cloth.

To remove stains, use an appropriate cleanser recommended by your authorized service representative.

**⚠ Caution** The machine exterior is plastic. Never use alcohol or solvent for cleaning.

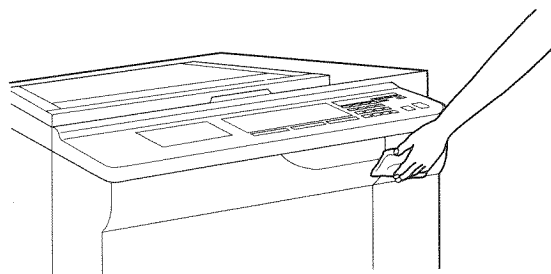

## Cleaning the Optional ADF Scanner Glass

76

### 1 Open the ADF Cover.

Open the ADF Cover while holding the ADF Cover Release Lever.

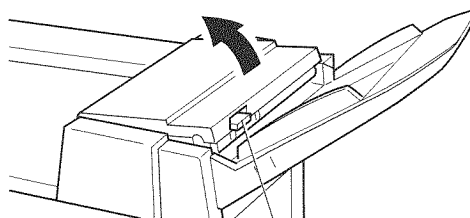

ADF Cover Release Lever

### 2 Wipe the Scanner Glass.

Gently wipe the Scanner Glass several times with a soft cloth or tissue.

**NOTE** For more effective cleaning, dampen a soft cloth or tissue with a small amount of alcohol before wiping the Scanner Glass.

**⚠ Caution** Since the Scanner Glass is very delicate, avoid shocks or scratching with a hard object.

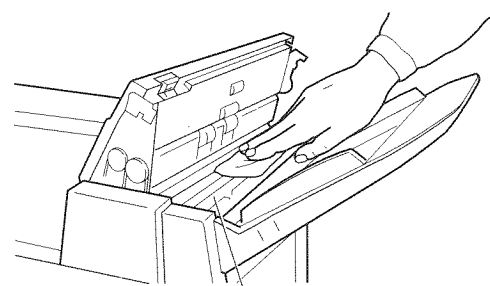

ADF Scanner Glass

## Cleaning the White Roller

### 1 Open the ADF Cover.

### 2 Rotating the White Roller, gently wipe it with soft cloth or tissue.

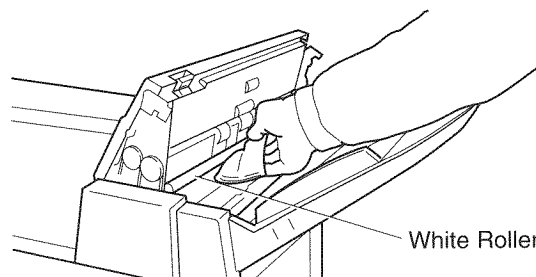

White Roller

# Appendices

This section includes information on options and specifications.

- **Optional Accessories** .....78
- **Specifications** .....79

# Index

## Symbols and Numerals

+ key (illustration)	10
+ key, using	42, 44, 47, 48, 49
* /CALL key (illustration)	10
* /CALL key, using	43, 45, 48
✕ key (illustration)	10
✕ key, using	42, 47, 48, 49
0/SAVE key (illustration)	10
0/SAVE key, using	47
1:1 key (illustration)	11
1:1 key, using	28, 29
2UP	38, 39

## A

accessories	78
adding paper	16
ADF cover release lever (illustration)	8 (ADF)
ADF original guides, adjusting	22 (ADF)
ADF original guides (illustration)	8 (ADF)
ADF originals, restrictions	15 (ADF)
ADF scanner glass, cleaning	76
ADF tray (illustration)	8 (ADF)
ADF unit (illustration)	8 (ADF)
adjustment of printing position, horizontal	33
adjustment of printing position, vertical	33
advice display	12
advisory messages (index)	63
advisory messages: requesting proper setting	64, 65
advisory messages: requesting supply and disposal	66
advisory messages: informing troubles	
in master-making area	66, 67
advisory messages: informing troubles	
in optional ADF unit	68
advisory messages: informing troubles	
in printing area	67, 68
advisory messages: requiring technical support	65
ALL RESET key (illustration)	10
ALL RESET key, using	22, 36
AUTO IDLE key (illustration)	11
AUTO IDLE key, using	51
AUTO PRINT	26
AUTO PRINT key (illustration)	10
AUTO PRINT key, using	26
Auto scanning contrast adjustment indicator	30
auto scanning contrast adjustment mode	30
Automatic Idle feature	51, 52
automatic printing	26
automatic sorting into groups	41

## B

basic display	12
basic processes	21
beep, 15-seconds (place second original)	39, 40
BOOK (ERASE)	15, 32
BOOK (PHOTO)	15, 32
bound documents, reproducing	32
bound original feature	32
BOUND ORIGINAL Selection key (illustration)	11
BOUND ORIGINAL Selection key, using	15, 32

## C

C/ERASE key (illustration)	10
C/ERASE key, using	49
CALL key, using	48
cautions, handling machine	20
cautions, installation	6
cautions, maintenance	74
cleaning ADF scanner glass	76
cleaning pressure roller	75
cleaning (preventing defective prints)	75
cleaning Risograph exterior	76
cleaning stage glass and stage cover	75
cleaning thermal print head	75
cleaning white roller	76
color, print	54, 78
color print cylinders	54, 78
computer interface	56
confidential documents, protecting	50
CONFIDENTIAL key (illustration)	11
CONFIDENTIAL key, using	50
control panel, checking	22
copyright infringement, caution	20
customizing initial settings	52

## D

defective prints, preventing	75
deleting saved settings	49
DENSITY mode	35
dimensions	79
discarding used masters	62
display, advice	12
display, basic	12
display (illustration)	11
display, initial setting selection	12
display, memory feature	12
display, program feature	12
displayed language	52
disposal box, master	62
documents, bound (reproducing)	32
documents, confidential	50
DOT	15, 31
DOT PHOTO Selection key (illustration)	11
DOT PHOTO Selection key, using	15, 31
dotted images, producing	31
DUO	15, 24

## E

enhanced photo images, producing	31
enhanced prints, producing	31
ENLARGE key (illustration)	11
ENLARGE key, using	29
enlargement, preset	28
enlarging originals	28
entering number of copies	23
environment, recommended	6
extension cord, capacity	6

## F

features	7, 79
feed tray down button (illustration)	8
feed tray down button, using	16

- feed tray paper guides (illustration) .....8  
 feed tray paper guides, using ..... 14, 16  
 flanges, master roll .....60, 61  
 front cover (illustration) .....9
- G**  
 groups, automatic sorting into.....41
- H**  
 half-tone processing.....24  
 handling machine, warnings and cautions.....20  
 horizontal adjustment of printing position .....33
- I**  
 I/F key, using.....56  
 image contrast on prints, changing.....30  
 image processing mode select, initial setting .....36  
 image processing modes .....15  
 images, dotted (producing) .....31  
 initial setting, image processing mode select .....36  
 initial setting, Main display .....36  
 initial setting, master-making/print .....36  
 initial setting, original scanning contrast .....36  
 initial setting, print position.....36  
 initial setting, print quantity display .....36, 52  
 initial setting, print speed/density.....36, 52  
 INITIAL SETTING SELECTION.....12, 52  
 initial setting selection display.....12  
 initial setting, size adjustment .....36  
 initial settings, customizing .....52  
 initial settings, return to.....36, 52  
 injury, avoiding.....6, 20, 74  
 ink cartridge, cautions .....59  
 ink cartridge (illustration).....9  
 ink cartridge locking lever (illustration).....9  
 ink cartridge, replacing.....58  
 interface (computer).....56  
 INTERFACE (I/F) key (illustration).....11
- J**  
 Job Separator III (optional accessory) .....41, 52, 78
- L**  
 Left/Right Print Position Adjustment Dial (illustration) ....8  
 Left/Right Print Position Adjustment Dial, using .....33  
 LINE .....15, 24  
 LINE/PHOTO key (illustration).....10  
 LINE/PHOTO key, using .....15, 24  
 lithium battery, replacing .....74  
 location, recommended.....6
- M**  
 main control panel (illustration).....8, 10  
 main display, about .....12  
 main display (illustration) .....10  
 main display, initial setting .....36  
 main power switch (illustration).....9  
 maintenance, cautions .....74  
 master disposal box, emptying and inserting .....62  
 master disposal box (illustration) .....8  
 master loading button (illustration).....9  
 master loading unit (illustration).....9  
 master loading unit release lever (illustration).....9  
 master roll cover (illustration).....9  
 master roll (illustration).....9  
 master roll, replacing.....60  
 master-making .....21  
 master-making, area limit.....52  
 master-making/print, initial setting .....36  
 MASTER-MAKING/PRINT key (illustration).....10  
 mechanical problems, avoiding .....6, 20, 74  
 memory feature .....46  
 memory feature display.....12  
 memory feature, saving .....47  
 MEMORY key (illustration).....10  
 MEMORY key, using .....47, 48, 49  
 MEMORY MODE .....47, 48, 49  
 (MIN.10, 20, 30) .....52  
 misfeeds, preventing.....14
- N**  
 number of copies (entering).....23
- O**  
 original, placing .....22  
 ORIGINAL SCANNING CONTRAST indicator  
 (illustration).....11  
 original scanning contrast, initial setting .....36  
 originals, enlarging.....28  
 originals, printing side by side.....38  
 originals, reducing.....28  
 originals, size recommendations.....15  
 originals, weight recommendations.....15
- P**  
 paper, adding .....16  
 paper arranger adjustment knob (illustration) .....9  
 paper arranger (illustration).....9  
 paper arrangers, setting .....17  
 paper arrangers, using.....14, 17, 18  
 paper capacity.....79  
 paper feed pressure adjustment lever (illustration) .....8  
 paper feed pressure adjustment lever, using .....14, 16  
 paper feed pressure, setting .....16  
 paper feed tray (illustration) .....8  
 paper feed tray, setting up.....16  
 paper jams, preventing .....14  
 paper receiving tray, closing .....18  
 paper receiving tray (illustration).....9  
 paper receiving tray, setting up.....17  
 paper, replacing .....16  
 paper, size recommendations.....14  
 paper stop (illustration) .....9  
 paper stop, using .....14, 18  
 paper, storing environment .....14  
 paper, weight recommendations.....14  
 PHOTO .....15, 24  
 PHOTO CONTRAST Enhancement key (illustration)....11  
 PHOTO CONTRAST Enhancement key, using.....15, 31  
 photo processing.....24  
 power connections, recommended.....6  
 power switch, turning on .....22

- preset enlargement, using .....28  
 preset reduction, using .....28  
 Preset Reduction/Enlargement size indicator  
   (illustration) .....11  
 PRESET SIZE/ZOOM Selection key (illustration) .....11  
 PRESET SIZE/ZOOM Selection key, using .....28, 29  
 pressure roller, cleaning .....75  
 preventing defective prints .....75  
 print color, changing .....54  
 print colors .....79  
 print cylinder (drum) handle (illustration) .....9  
 Print Cylinder (drum) Home Position button/indicator  
   (illustration) .....9  
 Print Cylinder (drum) Home Position button/indicator .....54  
 print cylinder (drum) (illustration) .....9  
 print cylinder (drum), operation .....21  
 print cylinders (drums), replacing .....54  
 PRINT DENSITY Adjustment keys, using .....35  
 print density, changing .....35  
 print position, adjusting .....33  
 print position, initial setting .....36  
 PRINT POSITION Adjustment key (illustration) .....11  
 PRINT POSITION Adjustment keys, using .....33  
 PRINT POSITION CENTER key (illustration) .....11  
 PRINT POSITION indicator .....11  
 Print Quantity Display (illustration) .....11  
 print quantity display, initial setting .....36, 52  
 Print Quantity keys (0 to 9) (illustration) .....10  
 print quantity, minimum .....52  
 PRINT SPEED Adjustment keys, using .....34  
 print speed, changing .....34  
 PRINT SPEED/DENSITY Adjustment key  
   (illustration) .....10  
 PRINT SPEED/DENSITY indicator (illustration) .....11  
 print speed/density, initial setting .....36, 52  
 PRINT SPEED/DENSITY Selection key (illustration) .....10  
 PRINT SPEED/DENSITY Selection key, using .....34, 35  
 printing .....21  
   printing, automatic .....26  
   printing, side-by-side (different originals) .....39  
   printing, side-by-side (same originals) .....38  
   printing, two-up (different originals) .....39  
   printing, two-up (same originals) .....38  
 prints, enhanced .....31  
 processing, half-tone .....24  
 processing, photo .....24  
 program A, setting up .....42  
 program B, setting up .....44  
 program feature display .....12  
 PROGRAM key (illustration) .....10  
 PROGRAM key, using .....41, 42, 44  
 proof copies, making .....25
- R**
- recalling, saved settings .....48  
 receiving tray paper guide adjustment knob  
   (illustration) .....9  
 receiving tray paper guides (illustration) .....9  
 receiving tray paper guides, using .....14, 17, 18  
 REDUCE key (illustration) .....11  
 REDUCE key, using .....29
- reducing originals .....28  
 reduction, preset .....28  
 Register Number, selecting .....47, 48, 49  
 replacing ink cartridge .....58  
 replacing lithium battery .....74  
 replacing master roll .....60  
 replacing paper .....16  
 Risograph exterior, cleaning .....76
- S**
- sample prints, making .....25  
 SAVE key, using .....47  
 saved settings, deleting .....49  
 saved settings, recalling .....48  
 scanner table release lever (illustration) .....8  
 SCANNING CONTRAST Adjustment key (illustration) .....11  
 SCANNING CONTRAST Mode key (illustration) .....11  
 scanning resolution .....79  
 SHIFTING .....33  
 side-by-side printing (different originals) .....39  
 side-by-side printing (same originals) .....38  
 size adjustment, initial setting .....36  
 SORTER key (illustration) .....11  
 sorting into groups, automatic .....41  
 SPEED mode .....34  
 stage cover (illustration) .....8  
 stage glass and stage cover, cleaning .....75  
 stage glass (illustration) .....8  
 START key (illustration) .....10  
 STOP key (illustration) .....10  
 storing environment, paper .....14  
 sub control panel (illustration) .....8, 11
- T**
- temperature range, recommended .....6  
 TEST PRINT key (illustration) .....10  
 TEST PRINT key, using .....25  
 test prints, making .....25  
 thermal print head, cleaning .....75  
 troubleshooting tips (index) .....69  
 TWO-UP key (illustration) .....11  
 TWO-UP key, using .....38, 39  
 two-up printing (different originals) .....39  
 two-up printing (same originals) .....38
- U**
- used masters, discarding .....62
- V**
- vertical adjustment of printing position .....33
- W**
- warnings, handling machine .....20  
 warnings, Maintenance .....74  
 warnings, power connection .....6  
 weight .....79  
 white roller, cleaning .....76
- Z**
- ZOOM .....29  
 zoom, using .....29

# Overview of Features

Your Risograph is a high-quality digital printer that is as easy to use as a copier.

- **Easy to Use and Fully Automatic**

The control panel shows you the features available and the current status of your Risograph with indicator lights, easy-to-read LCD displays, and includes a convenient "Machine Monitor" for troubleshooting.

Your Risograph processes your original by first making a master and then printing. The LCD display always shows the current process.

- **Print Speed and Density Control**

Any of five print speeds and densities can be selected for optimum performance.

- **Confidential Feature**

An original can be printed and the master can be automatically discarded to prevent further, unauthorized printing.

- **Image and Text Processing Options**

In addition to the standard processes for sharp line definition and accurate shading patterns, special photo contrast enhancement and 3-pattern dot-screen processes are available. The binding of a bound document can also be erased or lightened.

- **Color Printing Options**

Optional ink colors are available, by simply changing the Print Cylinder (Drum).

- **Zoom Enlargement and Reduction Capabilities**

Prints can be reduced or enlarged from 50% to 200% in 1% increments, according to your needs. Pre-set standard reduction and enlargement are also available (e. g., legal→letter or A3→A4).

- **Programmable Print Groupings**

Simple control panel entries can automate different types of groupings to save time finishing your print jobs.

- **Programmable Print Jobs**

Frequently used or complex print job settings can be stored in memory for instant recall.

- **Two-Up Printing**

Originals can be printed side by side on a single sheet.

- **Automatic Idle**

This feature ensures an excellent first copy when printing starts again after a period of idle time.

# Knowing the Parts and Components

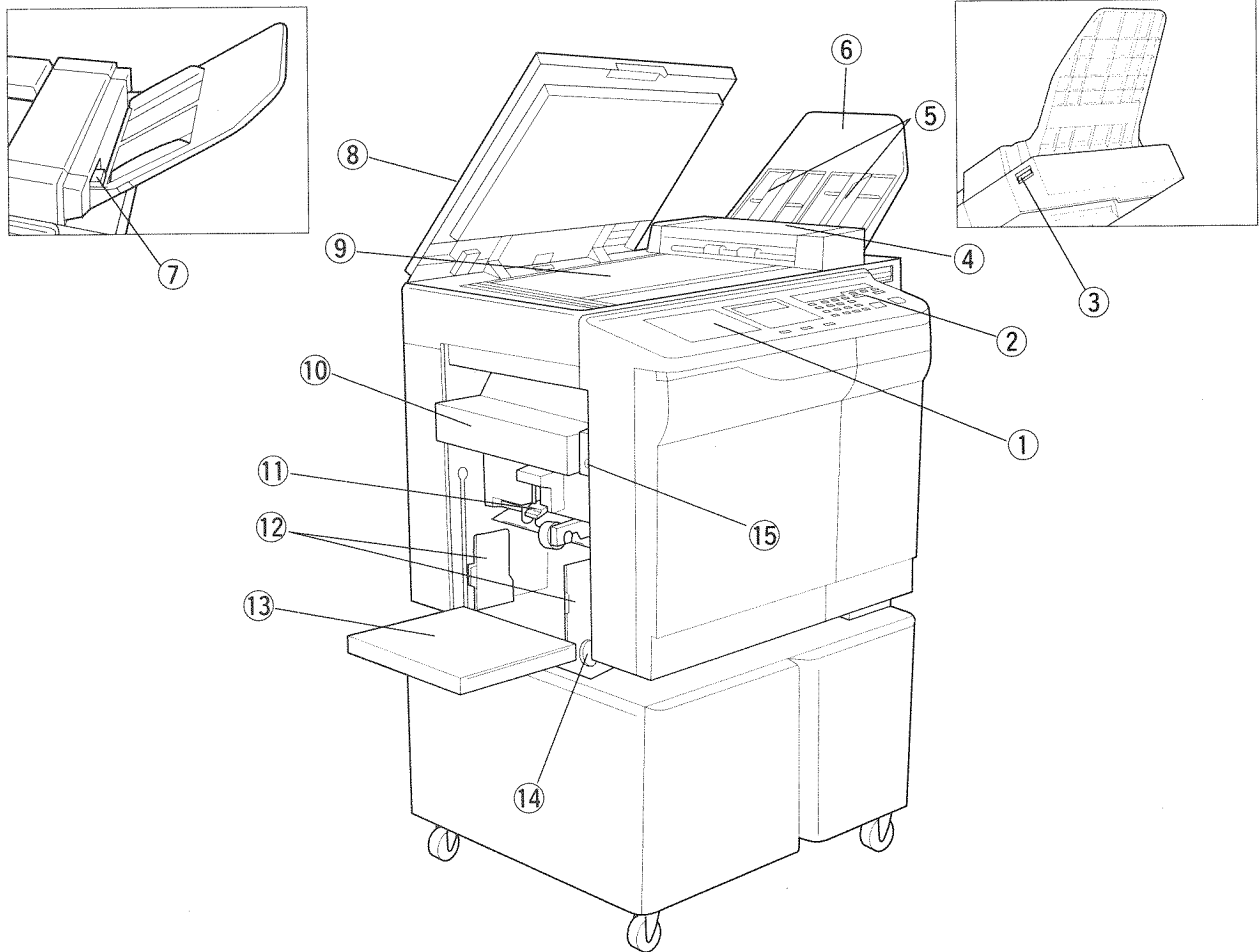

## Upper Area

- ① **Sub Control Panel** (↖ p.11)
- ② **Main Control Panel** (↖ p.10)
- ③ **Scanner Table Release Lever**  
Unlocks and opens the Scanner Table.
- ④ **ADF (Automatic Document Feeder) Unit**  
(↖ p.15)  
Feeds sheet originals into the scanner.
- ⑤ **ADF Original Guides** (↖ p.22)  
Holds and guides sheet originals for feeding.
- ⑥ **ADF Tray** (↖ p.22)  
Holds sheet originals for the ADF.
- ⑦ **ADF Cover Release Lever** (↖ p.76)  
Releases an original for removal when it is jammed in the ADF Unit.
- ⑧ **Stage Cover** (↖ p.75)  
Receives originals scanned through the ADF and secures the original placed on the Stage Glass.
- ⑨ **Stage Glass** (↖ p.75)

## Paper Feed Area

- ⑩ **Master Disposal Box** (↖ p.62)  
Holds discarded masters.
- ⑪ **Paper Feed Pressure Adjustment Lever**  
(↖ p.16)  
Adjusts the paper feed pressure according to the paper being used.
- ⑫ **Feed Tray Paper Guides** (↖ p.16)  
Holds and guides paper.
- ⑬ **Paper Feed Tray** (↖ p.16)
- ⑭ **Left/Right Print Position Adjustment Dial** (↖ p.33)  
Moves the print position to the left or right.
- ⑮ **Feed Tray Down Button** (↖ p.16)  
Lowers the Paper Feed Tray for replacing or adding printing paper.



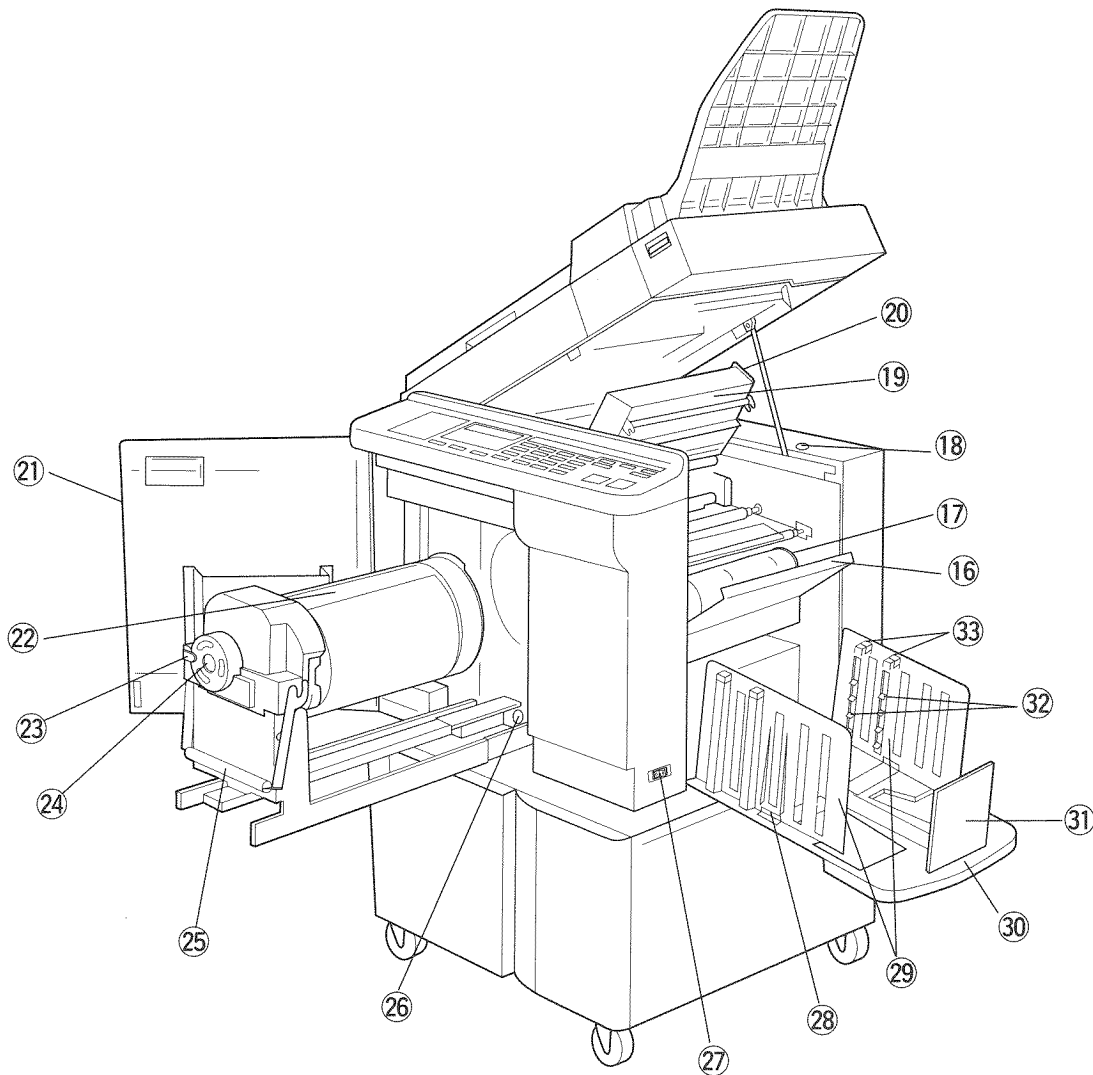

### Master-Making Area

- ①⑥ **Master Roll Cover** (☞ p.60)  
Protects the Master Roll.
- ①⑦ **Master Roll** (☞ p.60)
- ①⑧ **Master Loading Button** (☞ p.60)  
Loads as well as cuts the master.
- ①⑨ **Master Loading Unit** (☞ p.60)  
Makes a master from the scanned original.
- ②① **Master Loading Unit Release Lever**  
(☞ p.60)  
Opens the Master Loading Unit.

### Front Area

- ②② **Front Cover**
- ②② **Print Cylinder (Drum)** (☞ p.54)  
Holds the master.
- ②③ **Ink Cartridge Locking Lever** (☞ p.58)  
Secures the Ink Cartridge in position.
- ②④ **Ink Cartridge** (☞ p.58)
- ②⑤ **Print Cylinder (Drum) Handle** (☞ p.54)  
Used to slide the Print Cylinder (Drum) forward.

- ②⑥ **Print Cylinder (Drum) Home Position Button/Indicator** (☞ p.54)  
Positions and unlocks the Print Cylinder (Drum) for removal.
- ②⑦ **Main Power Switch** (☞ p.22)

### Paper Receiving Area

- ②⑧ **Receiving Tray Paper Guide Adjustment Knob** (☞ p.17)
- ②⑨ **Receiving Tray Paper Guides** (☞ p.17)  
Aligns printed paper neatly.
- ③① **Curved Paper Receiving Tray** (☞ p.17)
- ③① **Paper Stop** (☞ p.18)  
Stops printed paper ejected into the Paper Receiving Tray.
- ③② **Paper Arranger** (☞ p.17)  
Helps arrange printed paper ejected into the Paper Receiving Tray.
- ③③ **Paper Arranger Adjustment Knob** (☞ p.17)

# The Control Panel

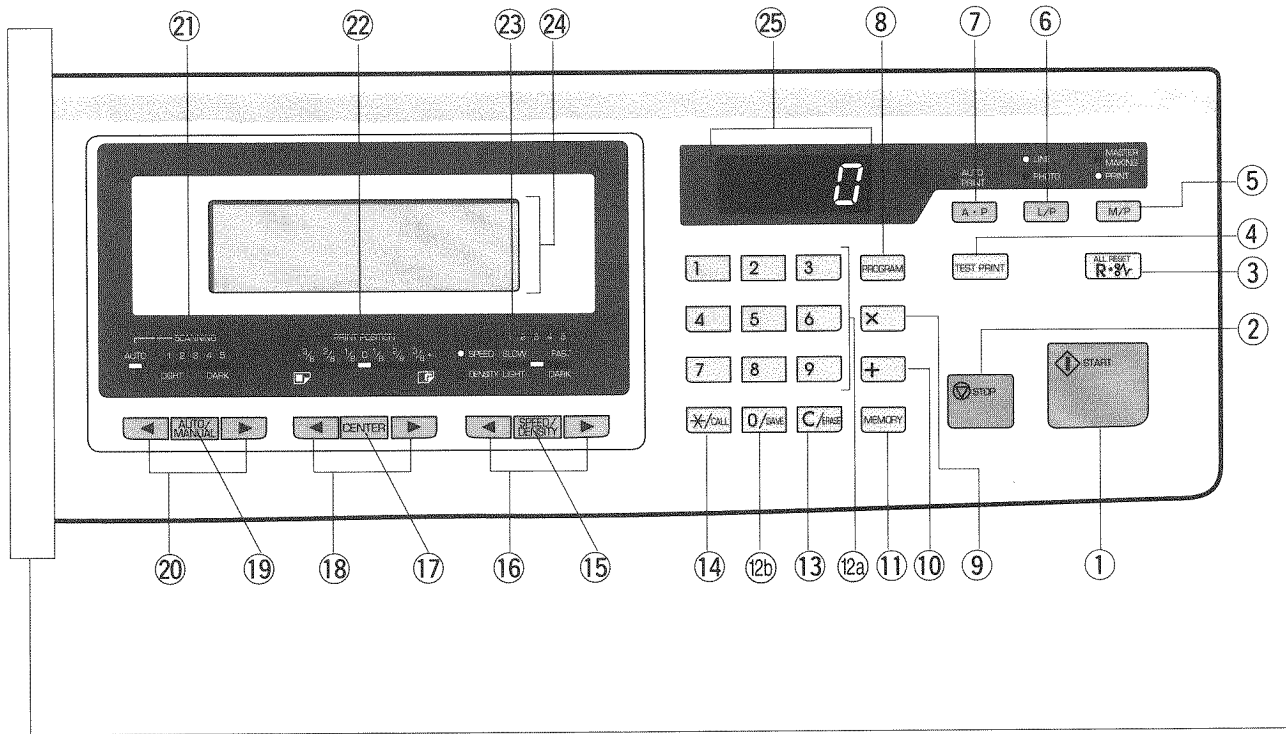

## Main Control Panel

- ① **START Key**  
Starts printing or master-making process. The indicator is "GREEN" when the key is active. This key is also used to resume operation after troubleshooting.
- ② **STOP Key**  
Interrupts printing, and cancels confidential feature.
- ③ **R • 9V (ALL RESET) Key** (see p.36)  
Returns all settings to initial status. This key is also used to clear error messages after troubleshooting.
- ④ **TEST PRINT Key** (see p.25)  
Prints a sample from the current master to allow you to check print quality and printing position.
- ⑤ **MASTER-MAKING/PRINT (M/P) Key**  
Switches between Master-Making and Printing operations. Normally, selection is made automatically according to the current process.
- ⑥ **LINE/PHOTO Key** (see p.24)  
Switches the current processing mode among Line, Photo and Duo. The indicators light according to the selected mode.
- ⑦ **AUTO PRINT Key** (see p.26)  
Automates the process of master-making through printing. The indicator lights when the feature is active.
- ⑧ **PROGRAM Key** (see pp.41-45)  
Provides access to programmed grouping of prints.
- ⑨ **X Key** (see pp.41-45)  
Use when making program settings.
- ⑩ **+ Key** (see pp.41-45)  
Use when making program settings.
- ⑪ **MEMORY Key** (see pp.46-49)  
Provides access to the Memory features.
- ⑫a **Print Quantity Keys (0 to 9 Keys)**  
Use these keys to enter the number of copies to be printed, or to enter other numeric values.
- ⑫b **0/SAVE Key** (see p.47)  
Use to store settings in memory.
- ⑬ **C/ERASE Key** (see p.49)  
Cancels the number entered and resets the Print Quantity Display to zero. Also erases contents of memory.
- ⑭ **\*/CALL Key** (see p.48)  
Use for memory recall.
- ⑮ **PRINT SPEED/DENSITY Selection Key** (see p.34,35)  
Switches between print speed and printing density modes. The indicators light when the mode is active.
- ⑯ **PRINT SPEED/DENSITY Adjustment Keys (< >)** (see p.34,35)  
Adjusts print speed or density (on a 1 to 5 scale).

# Originals and Processing

## Size and Weight Restrictions

### Using the Stage Glass

The Stage Glass can be used to print from bound originals or sheet originals or to print from originals that have an irregular shape or size. You can place originals from 2" × 3 1/2" (business card, 50 × 90 mm) size to 11" × 17" (ledger size, or A3) on the Stage Glass. The weight of bound originals should be 22 lb (10 kg) or less.

The Stage Glass can also be used when the original is not recommended for use with the ADF.

The margins indicated on the figure to the right are required for the original. Reduce the original if necessary to fit it inside these margins.

- NOTE**
- If an original is wrinkled, curled, or creased, flatten it thoroughly so that the originals can be pressed directly onto the Stage Glass during processing.
  - If correction fluid or glue is used on an original, thoroughly dry it before you place the original on the Stage Glass.

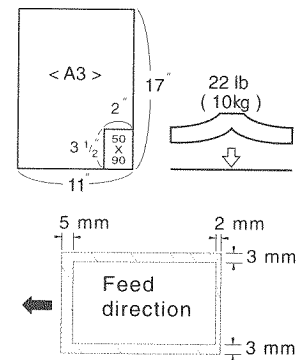

### Using the ADF

You can use the ADF (Automatic Document Feeder) to feed automatically up to 50 original sheets from 4" × 6" (postcard size, A6, or 100 × 148 mm) to 11" × 17" (ledger, A3, or 297 × 420 mm) size. The weight of the original sheets should be between 15-lb bond (50g/m<sup>2</sup>) and 28-lb bond (110g/m<sup>2</sup>).

**NOTE** Use the Stage Glass when printing the following originals:

- Patched or worn originals
- Wrinkled, curled, folded, or torn originals
- Transparent originals (such as tracing paper or OHP transparencies)
- Chemically treated originals (such as thermal or carbon paper)
- Originals with correction fluid or glue
- Extremely thin originals (less than 15-lb bond (50g/m<sup>2</sup>))
- Extremely thick originals (greater than 28-lb bond (110g/m<sup>2</sup>))
- Heavy drawing paper
- Bound originals
- Originals with staples or clips

## Guides for Selecting Processing

You can use various image processing modes to produce printed copies according to the contents of the original.

- L/P Key (LINE/PHOTO) - ( p.24)

- LINE For ordinary documents with lines and text.
- PHOTO To reproduce different shades of photo or half-tone images.
- DUO To reproduce photo or half-tone images clearly without deteriorating line sharpness.

- PHOTO CONTRAST Enhancement Key (LIGHT/DARK) - ( p.31)

- LIGHT To decrease shades of a photo original.
- DARK To increase shades of a photo original.

- DOT PHOTO Selection Key (DOT /DOT /DOT ) - ( p.31)

To process a photo original using a dot screen.

- BOUND ORIGINAL Selection Key (PHOTO/ERASE) - ( p.32)

- PHOTO To print a two-page spread of a bound original on one sheet with the binding shadow lightened.
- ERASE To print a two-page spread of a bound original on one sheet with the binding shadow erased.

# Preparing to Print

## Setting Up the Paper Feed Tray

**1** Open the Paper Feed Tray.

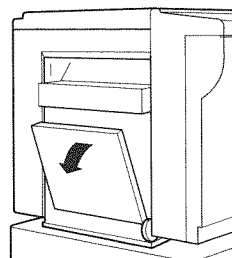

**2** Load printing paper and slide the Feed Tray Paper Guides to fit the paper width.

**Important!**  
Do not mix printing paper of different sizes.

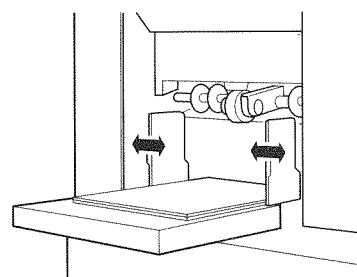

**3** Set the paper feed pressure.

Position the Paper Feed Pressure Adjustment Lever at either "NORMAL" or "CARD," according to the paper to be used.

- NORMAL      Standard paper
- CARD        Thick paper such as card stock

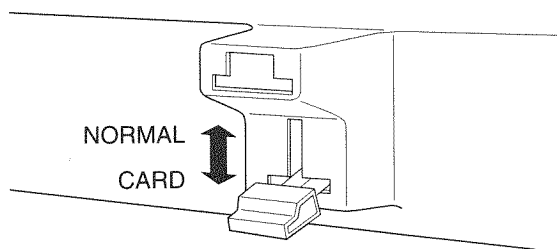

## Adding or Replacing Paper

If you want to add paper or use paper of different size during printing, lower the Paper Feed Tray so that you can load the paper easily.

To lower the Paper Feed Tray, hold down the Feed Tray Down button.

**Important!**  
Do not mix different paper sizes in the Paper Feed Tray.

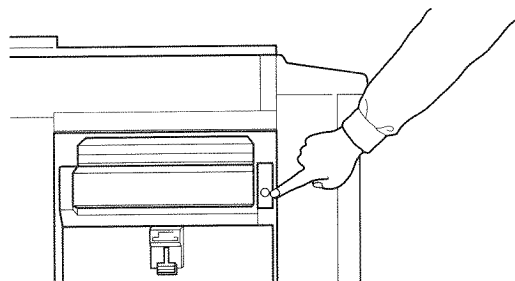

# Basic Processes

The basic processes of your Risograph can be divided into two stages: making a master of an original (master-making), and then printing copies from the master. Your Risograph has been designed so that these two processes flow smoothly from one to the other, with the current action shown clearly in the display.

## Master-Making

When you create a master, an original is scanned. The master is imaged and then automatically placed on the Print Cylinder (Drum).

**1 Set an original in place.**

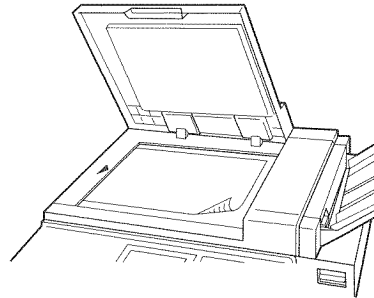

**2 Scan the original.**

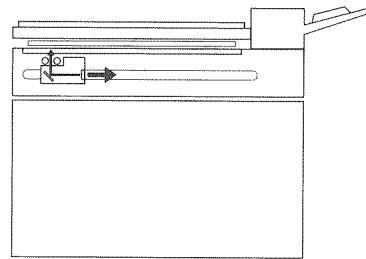

**3 Create a master.**

The master is placed on the Print Cylinder (Drum) and a proof copy is produced.

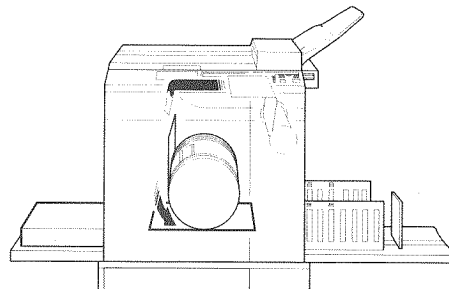

## Printing

When you print, the Print Cylinder (Drum) rotates to print the specified number of copies.

**4 Enter the number of copies you want.**

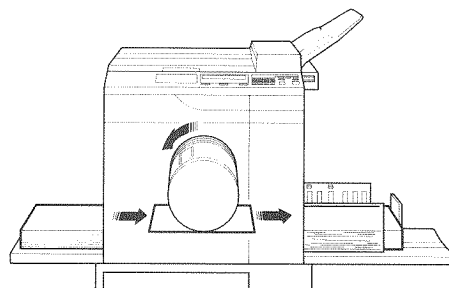

**5 Start printing.**

# Basic Operation

## 1 Turn the power switch ON.

The power switch is located on the lower right side of the machine.

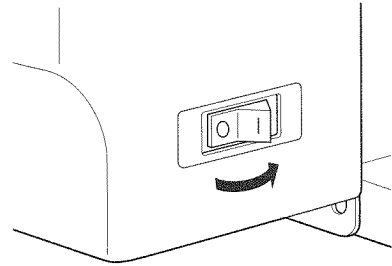
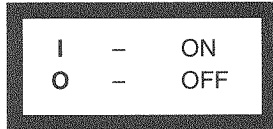

## 2 Check the settings on the control panel.

When the power is connected, the Main Display and control panel indicators show the initial settings.

Make any necessary changes, such as reproduction ratio and processing mode.

Holding down the **R • %v (ALL RESET)** key longer than one second returns the control panel to the initial settings.

- ☞ **p.36** ...Return to initial settings.
- ☞ **p.52** ....You can customize the initial settings.
- ☞ **p.47,48**....Frequently used combinations of settings can be saved in memory for quick recall.

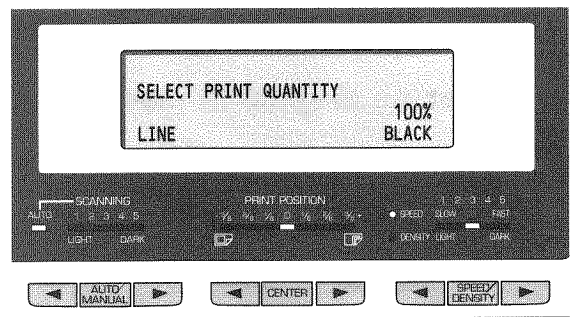

## 3 Open the ADF Tray.

Rotate the ADF Tray, folded on the ADF Unit, by 180° outward.

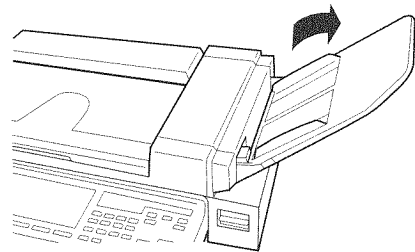

## 4 Place an original on the ADF Tray or the Stage Glass.

- If placing originals on the ADF Tray, adjust the ADF Original Guides to the width of the originals. Then insert the originals face down into the ADF Unit until they stop. The originals are automatically fed and set into place.

**NOTE** A maximum of 50 originals can be set into place on the ADF Tray at one time.

- If placing originals on the Stage Glass, open the Stage Cover and place an original face down. Position the original according to the indicators on the left-hand side of the glass. Close the cover, resting it gently on the original.

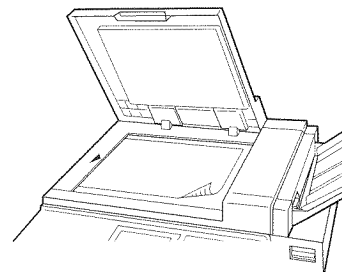
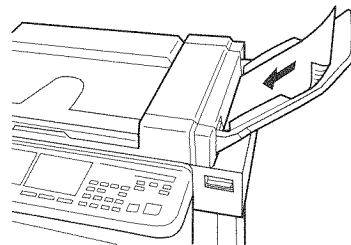

**⚠ Caution** Do not force the cover down on top of a bound original placed on the Stage Glass.

**NOTE** When an original is in place, processing automatically changes to Master-Making from Printing. The "READY TO MAKE MASTER" message appears in the Main Display and the MASTER-MAKING indicator on the control panel lights.

**5 Press the START key.**

After an original is scanned, a master is created. A test print is automatically printed to allow you to check the print quality, position, and density.

**p.33** .....To change the position of the printed image, press the PRINT POSITION Adjustment keys, and/or turn the Left/Right Print Position Adjustment Dial.

**p.35** ....To change the printing density of the printed copies, change the print density setting.

If settings are changed, press the TEST PRINT key to check the results.

**6 Enter the number of copies to be printed.**

Specify the number of copies to be printed using the Print Quantity keys; the number is displayed in the Print Quantity Display.

**NOTE** If you enter a number incorrectly, press the C key to reset the Print Quantity Display to zero, then enter the correct number.

**7 Press the START key.**

The specified number of copies is printed.

**NOTE** If printing stops and the "ADD PAPER" message appears in the Main Display, paper has run out in the Paper Feed Tray. Load paper into the tray.

**p.16**

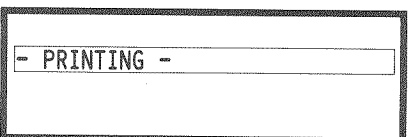
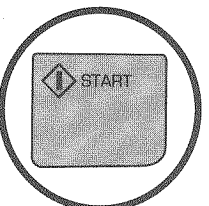
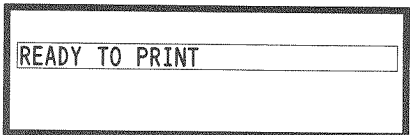
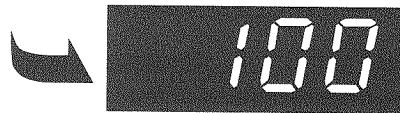
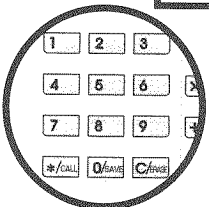
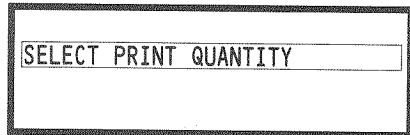
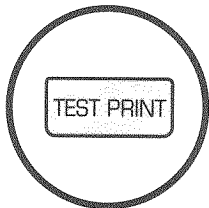
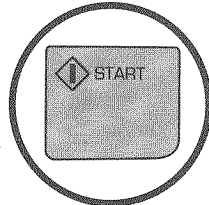
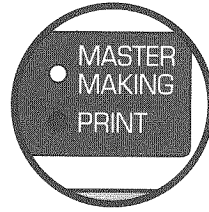

# Photo/Half-Tone Processing

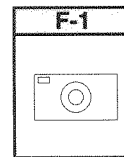

If an original contains photographs or half-tone images, or a multi-colored original is used, select PHOTO or DUO processing by holding down the LINE/PHOTO key. The current selection appears in the Main Display.

Since the image is processed graphically, degrees of shading are accurately reproduced.

## PHOTO

Reproduces different shades of photograph or half-tone images most clearly.

Lines and texts become less sharp if they are included in an original.

## DUO

Reproduces photograph or half-tone images clearly without deteriorating the sharpness of lines and texts.

This processing mode is recommended for multi-colored originals or photo originals with sharp lines and texts included.

**p.30**.....The scanning contrast setting should be checked and adjusted according to image density, if necessary.

- NOTE**
- If DUO is selected for light-density originals, lines might be broken. In this case, select LINE.
  - If LINE is selected to print an original that contains a darkly shaded photograph, on the other hand, copies might be smudged. In this case, select PHOTO or DUO.
  - The Digitizer III (optional) cannot be used simultaneously with the duo processing mode.

**Holding down the R •  (ALL RESET) key longer than one second returns processing to the initial setting.**

**p.47, 48**.....The selected processing can be saved in memory for quick recall.

**p.52**.....You can customize initial settings.

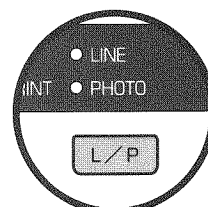
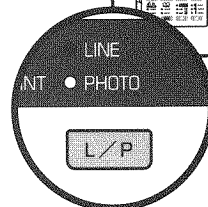
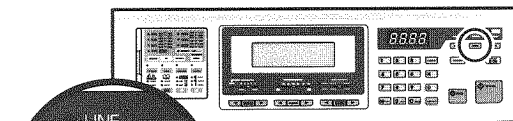



# Producing Proof Copies

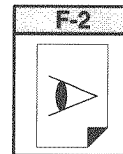

If changes have been made to the print position and other settings, check the print quality by producing proof copies.

By holding down the TEST PRINT key, you can print continuously.

**NOTE** Test printing does not affect the quantity in the Print Quantity Display.

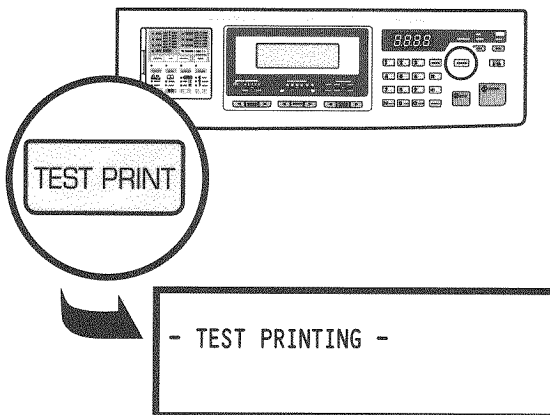

# Automatic Printing

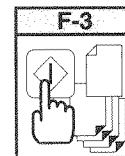

If you do not need to check print samples before making prints, press the AUTO PRINT key before pressing the START key to activate the Auto Print feature. This feature enables nonstop operation from master-making through printing.

**NOTE** If you need to check or adjust the print position, cancel the Auto Print feature by pressing the AUTO PRINT key again.

## 1 Press the AUTO PRINT key.

The Auto Print Indicator lights and the "AUTO PRINT" message appears in the Main Display.

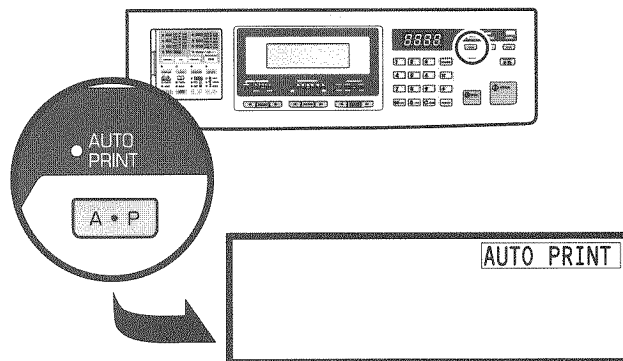

## 2 Set an original into place.

- Insert originals face down into the ADF Unit until it stops. A maximum of 50 originals can be placed on the ADF Tray at one time.
- Open the Stage Cover and place an original face down on the Stage Glass. Close the cover gently on the original.

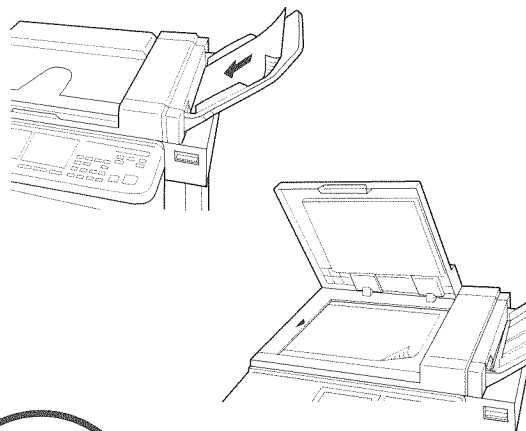

## 3 Enter the number of copies to be printed.

**NOTE** If you enter a number incorrectly, press the C key to reset the Print Quantity Display to "0," then enter the correct number.

If "0" is selected as the print quantity, the machine will not start.

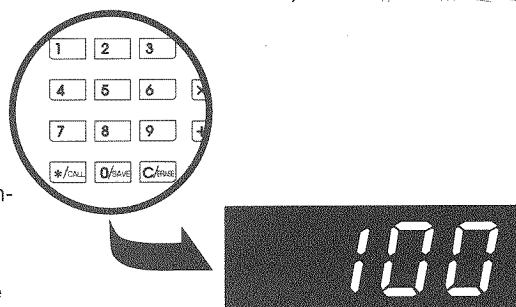

## 4 Press the START key.

The specified number of copies are produced with an extra proof copy.

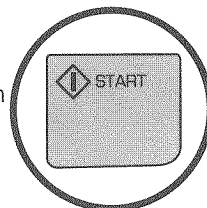

**p.47,48** .....The Auto Print feature can be saved in memory for quick recall.

**Holding down the R • % (ALL RESET) key longer than one second returns the Auto Print feature to the initial setting.**

**p.52** .....You can customize initial settings.

# Printing Two Different Originals Two-Up

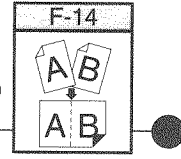

## Using the Same Settings for Two Originals

Normally you can make Two-Up prints from two different originals by placing them on the Stage Glass side by side. If you wish to make Two-Up prints from more than two originals continuously, activate the Auto Print and Two-Up features and place the originals on the ADF Tray.

For the Auto Print feature, refer to the page 26.

If different pages of a bound document are to be used to produce Two-Up prints, change the initial setting of the Two-Up feature and then place the bound document on the Stage Glass.

The machine scans the first page and then provides a 15 second period (a beep sounds) for you to place the second page. (Refer to the description on the next page for the procedure of changing the initial setting of the Two-Up feature.)

### 1 Press the TWO-UP key to activate the Two-Up feature.

The Two-Up indicator lights and "2 UP" message appears in the Main Display when the feature is active.

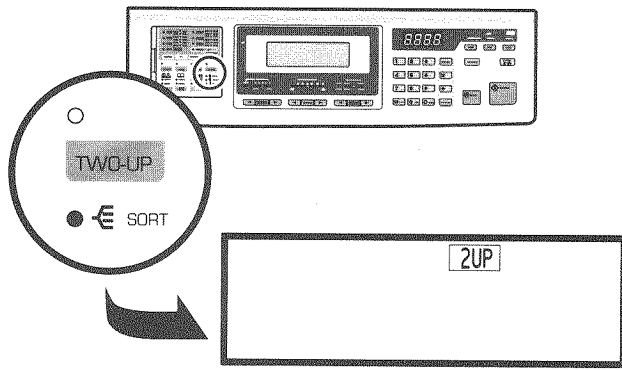

### 2 Place originals face-down on the ADF Tray.

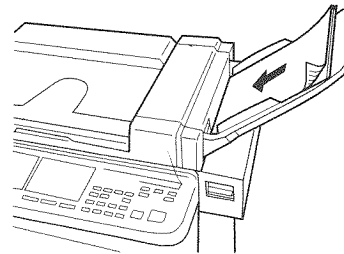

### 3 Press the START key.

The originals are scanned and the Two-Up master is made. The specified number of Two-Up prints are produced with an extra test print.

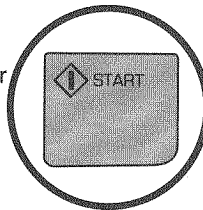

**NOTE** If more than two originals are placed on the ADF Tray, the Two-Up feature remains active.

39 Optional ADF

## Changing Settings for One Original

When different settings are required for two originals, place them on the ADF Tray individually. The machine scans the first original and then provides a 15 second period (a beep sounds) for you to place the second original.

**NOTE** If you press the STOP key or do not place the second original during the 15-second period, the sample print will be produced with one side blank.

**1 Press the TWO-UP key to activate the Two-Up feature.**

The Two-Up indicator lights and "2UP" message appears in the Main Display when the feature is active.

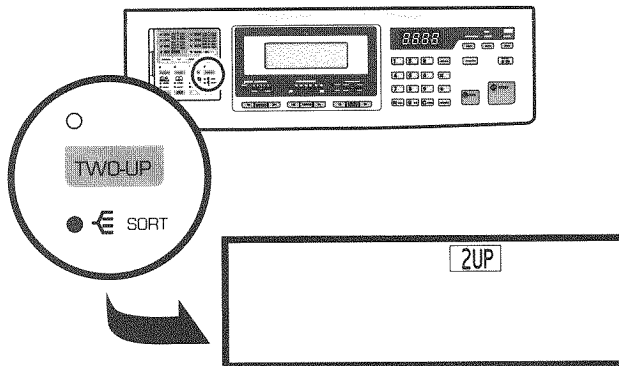

**2 Place an original face-down on the ADF Tray.**

**NOTE** If bound documents are used for this purpose, change the initial setting of the Two-Up feature and then place the bound document on the Stage Glass. (Refer to the description below for the procedure of changing the initial setting of the Two-Up feature.)

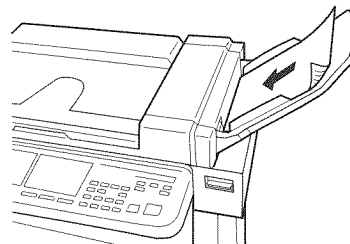

**3 Press the START key.**

After the first original is scanned, a 15-second beep sounds.

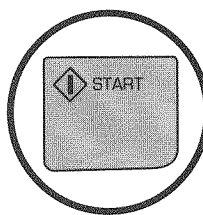

**4 During the 15-second beep enter the settings for the second original, if necessary and place the second original on the ADF Tray (or the Stage Glass for the bound document).**

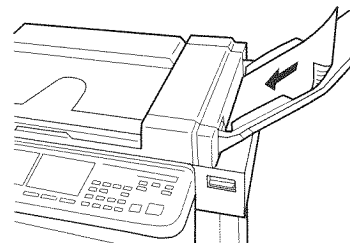

After the second original is scanned, a sample Two-Up print is automatically printed.

**Procedure of Changing the Initial Setting of the Two-Up Feature**

**1 Open the Initial setting selection program and select the item No.11.**

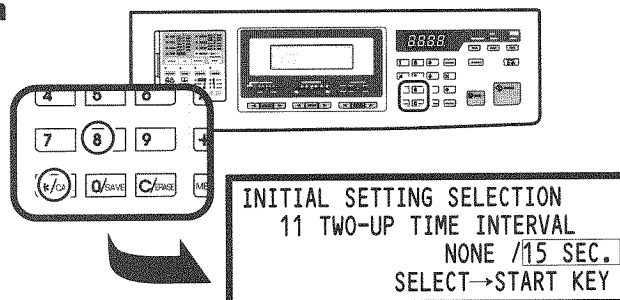

**2 Select "15 SEC." to provide a 15-second interval for placing the second original on the Stage Glass.**

# Specifications

<b>Processing</b>	High-speed automatic digital scanning/fully automatic, thermal screening duplicating system
<b>Time to First Copy</b>	Ledger or A3 original : approx. 29 seconds Letter or A4 original : approx. 22 seconds
<b>Print Speed</b>	5 selectable print speeds (60 to 120 sheets per minute)
<b>Scanning Resolution</b>	600 × 600 dpi
<b>Original Input Type</b>	Bound documents or sheets
<b>Original Size</b>	- For the Stage Glass : 2" × 3 1/2" (business card, or 50 × 90 mm) to 11" × 17" (ledger, A3, or 297 × 420 mm) - In the optional ADF Unit : 4" × 6" (postcard, A6, or 100 × 148 mm) to 11" × 17" (ledger, A3, or 297 mm × 420 mm)
<b>Output Paper Size</b>	4" × 6" (postcard, or A6) to 11" × 17" (ledger, or A3)
<b>Original Weight</b>	- For the Stage Glass : 22 lbs. (10 kg) or less - In the optional ADF Unit : 15-lb bond (50 g/m <sup>2</sup> ) to 28-lb bond (110g/m <sup>2</sup> )
<b>Paper Weight</b>	13-lb bond (46 g/m <sup>2</sup> ) to 110-lb index stock (210 g/m <sup>2</sup> )
<b>Image Area</b>	Ledger Cylinder (Drum) - 10.7" × 16.5" (273 × 420 mm) A3 Cylinder (Drum) - 11.4" × 16.2" (290 × 412 mm)
<b>Paper Capacity</b>	1000 sheets in feed and receiving tray (16-lb bond or 64 g/m <sup>2</sup> )
<b>Optional ADF Capacity</b>	50 originals
<b>Enlargement Parameters</b>	3 selectable enlargements: 141%, 127% and 121% (141%, 122% and 116% for metric models)
<b>Reduction Parameters</b>	4 selectable reductions: 94%, 77%, 75% and 66% (94%, 87%, 82% and 71% for metric models)
<b>Zooming Parameters</b>	50% to 200%
<b>Features</b>	<ul style="list-style-type: none"><li>• Print Speed/Density control (auto/manual)</li><li>• Confidential mode</li><li>• Two-Up printing</li><li>• Bound Book processing</li><li>• Programmed printing</li><li>• Memory storage of frequently used settings</li><li>• Duo processing</li><li>• Photo Contrast enhancement</li><li>• Dot-screening</li><li>• Photo enhancement</li><li>• Interface capabilities</li><li>• Automatic idle</li><li>• Scanning contrast adjustment (auto/manual)</li><li>• Automatic Jump wing (Ejection Guide) control</li><li>• Precision stacking tray</li></ul>
<b>Print Colors</b>	A wide range of colors including : black, blue, red, green, brown, yellow, etc.
<b>Optional Accessories</b>	Color Cylinder (Drum), Letter (A4) Cylinder Digitizer III, Sorter TM5000, Sorter TM2500, Sheet Feeder SF3000, Job Separator III, Key/Card Counter III and Computer Interface
<b>Power Source</b> <b>&lt;Requirements&gt;</b>	USA Model           • 120 V AC, 60 Hz <5 A> Metric Models:   • 110 V AC, 60 Hz <5 A> (110 V model) • 220-240 V AC, 50/60 Hz <2 A> (220 V model)
<b>Weight</b>	Approx. 258 lbs. (116 kg)
<b>Dimensions (W × D × H)</b>	In use: 51.8" × 26.3" × 32.7" (1316 × 669 × 832 mm) In storage: 29.3" × 26.3" × 28.1" (745 × 669 × 715 mm)

**NOTE** The specifications are subject to change without prior notice. Please acknowledge that the illustrations and descriptions in this manual may differ from the actual machine, due to the change in specifications.

79

Optional ADF

# Index

## Symbols and Numerals

+ key (illustration)	10
+ key, using	42, 44, 47, 48, 49
* /CALL key (illustration)	10
* /CALL key, using	43, 45, 48
× key (illustration)	10
× key, using	42, 47, 48, 49
0/SAVE key (illustration)	10
0/SAVE key, using	47
1:1 key (illustration)	11
1:1 key, using	28, 29
2UP	38, 39

## A

accessories	78
adding paper	16
ADF cover release lever (illustration)	8 (ADF)
ADF original guides, adjusting	22 (ADF)
ADF original guides (illustration)	8 (ADF)
ADF originals, restrictions	15 (ADF)
ADF scanner glass, cleaning	76
ADF tray (illustration)	8 (ADF)
ADF unit (illustration)	8 (ADF)
adjustment of printing position, horizontal	33
adjustment of printing position, vertical	33
advice display	12
advisory messages (index)	63
advisory messages: requesting proper setting	64, 65
advisory messages: requesting supply and disposal	66
advisory messages: informing troubles	
in master-making area	66, 67
advisory messages: informing troubles	
in optional ADF unit	68
advisory messages: informing troubles	
in printing area	67, 68
advisory messages: requiring technical support	65
ALL RESET key (illustration)	10
ALL RESET key, using	22, 36
AUTO IDLE key (illustration)	11
AUTO IDLE key, using	51
AUTO PRINT	26
AUTO PRINT key (illustration)	10
AUTO PRINT key, using	26
Auto scanning contrast adjustment indicator	30
auto scanning contrast adjustment mode	30
Automatic Idle feature	51, 52
automatic printing	26
automatic sorting into groups	41

## B

basic display	12
basic processes	21
beep, 15-seconds (place second original)	39, 40
BOOK (ERASE)	15, 32
BOOK (PHOTO)	15, 32
bound documents, reproducing	32
bound original feature	32
BOUND ORIGINAL Selection key (illustration)	11
BOUND ORIGINAL Selection key, using	15, 32

## C

C/ERASE key (illustration)	10
C/ERASE key, using	49
CALL key, using	48
cautions, handling machine	20
cautions, installation	6
cautions, maintenance	74
cleaning ADF scanner glass	76
cleaning pressure roller	75
cleaning (preventing defective prints)	75
cleaning Risograph exterior	76
cleaning stage glass and stage cover	75
cleaning thermal print head	75
cleaning white roller	76
color, print	54
color print cylinders	54, 78
computer interface	56
confidential documents, protecting	50
CONFIDENTIAL key (illustration)	11
CONFIDENTIAL key, using	50
control panel, checking	22
copyright infringement, caution	20
customizing initial settings	52

## D

defective prints, preventing	75
deleting saved settings	49
DENSITY mode	35
dimensions	79
discarding used masters	62
display, advice	12
display, basic	12
display (illustration)	11
display, initial setting selection	12
display, memory feature	12
display, program feature	12
displayed language	52
disposal box, master	62
documents, bound (reproducing)	32
documents, confidential	50
DOT	15, 31
DOT PHOTO Selection key (illustration)	11
DOT PHOTO Selection key, using	15, 31
dotted images, producing	31
DUO	15, 24

## E

enhanced photo images, producing	31
enhanced prints, producing	31
ENLARGE key (illustration)	11
ENLARGE key, using	29
enlargement, preset	28
enlarging originals	28
entering number of copies	23
environment, recommended	6
extension cord, capacity	6

## F

features	7, 79
feed tray down button (illustration)	8
feed tray down button, using	16

# Register Sheet for Memory Feature

REGISTER NO. <DATE>	MEMORIZED STATUS	REGISTER NO. <DATE>	MEMORIZED STATUS
<b>1</b>  < / >	----- ----- -----	<b>11</b>  < / >	----- ----- -----
<b>2</b>  < / >	----- ----- -----	<b>12</b>  < / >	----- ----- -----
<b>3</b>  < / >	----- ----- -----	<b>13</b>  < / >	----- ----- -----
<b>4</b>  < / >	----- ----- -----	<b>14</b>  < / >	----- ----- -----
<b>5</b>  < / >	----- ----- -----	<b>15</b>  < / >	----- ----- -----
<b>6</b>  < / >	----- ----- -----	<b>16</b>  < / >	----- ----- -----
<b>7</b>  < / >	----- ----- -----	<b>17</b>  < / >	----- ----- -----
<b>8</b>  < / >	----- ----- -----	<b>18</b>  < / >	----- ----- -----
<b>9</b>  < / >	----- ----- -----	<b>19</b>  < / >	----- ----- -----
<b>10</b>  < / >	----- ----- -----	<b>20</b>  < / >	----- ----- -----

Please use this sheet as an original for duplication.



**Please contact following for supplies and service:**